

حوظ ما يريده الخباز لصنع الخبز اللذيذ.

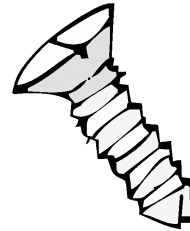

صل الأداة بالشئ المناسب لها .

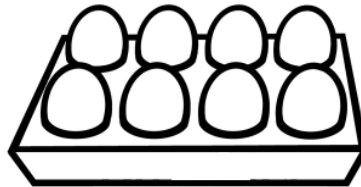
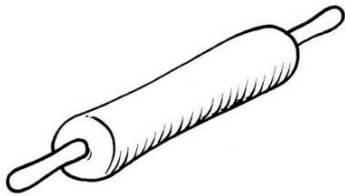
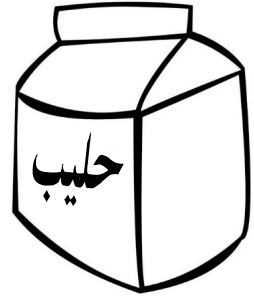
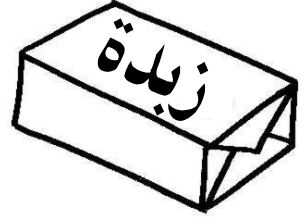
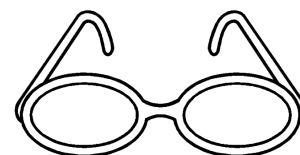
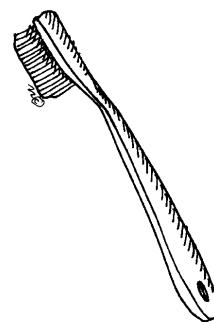
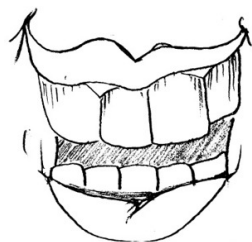
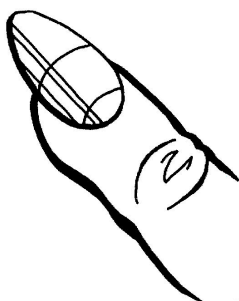
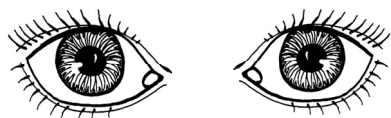

اسئلي طفلك عن لون التفاح الذي يجبه (الأحمر، الأصفر، الأخضر) من ثم يصنع دوائر التفاح على الدوائر الموجودة حالياً على الشجرة باستخدام أعواد تنظيف الأذن بعد أن يضع طرف العود القطني في معجون الألوان.

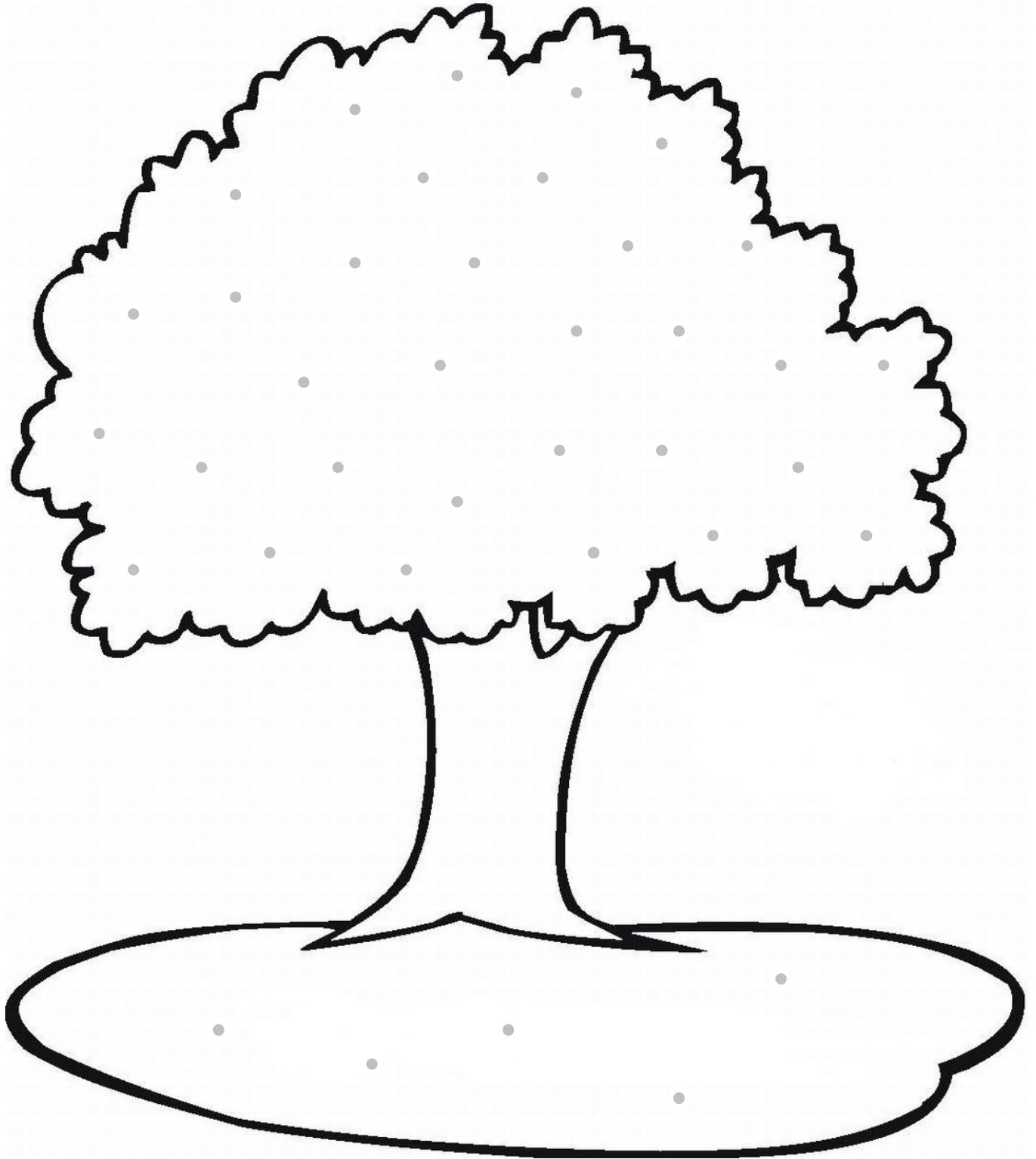

نون ما تلبسه في يوم ممطر.

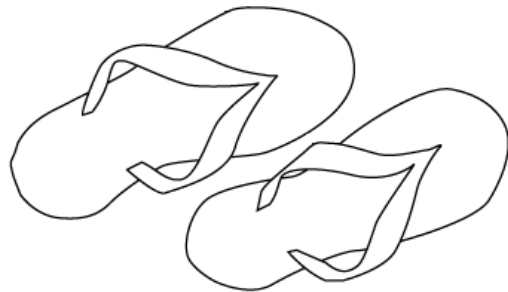
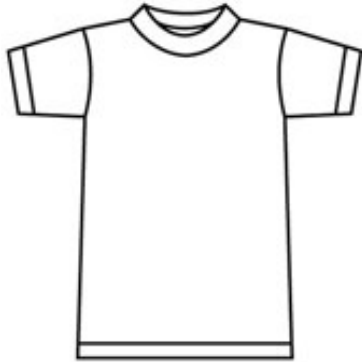

صل كل بيت بالبيت المطابق له ، ثم حوط البيت الكبير باللون الأحمر والبيت الصغير باللون الأزرق.

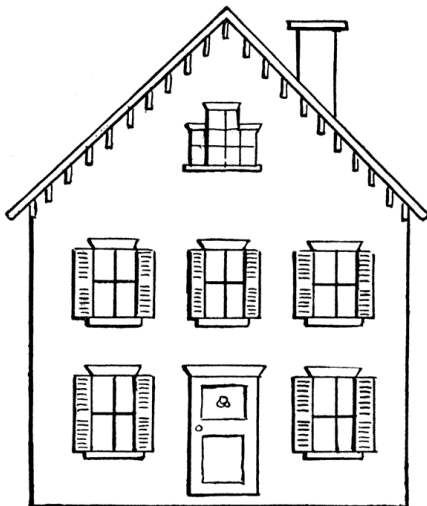
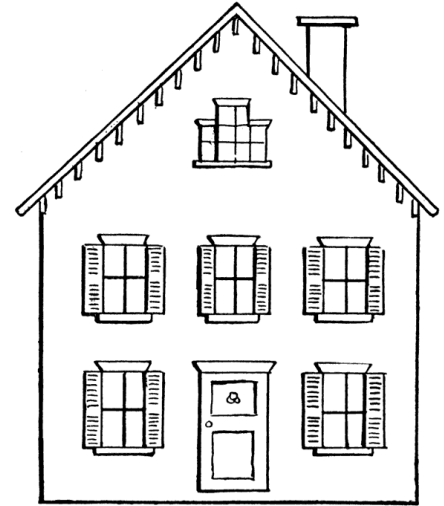
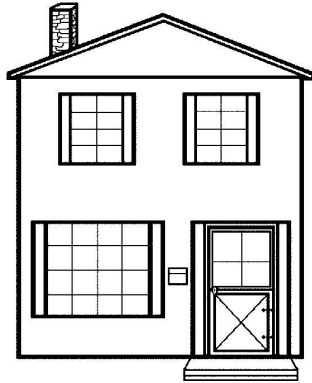
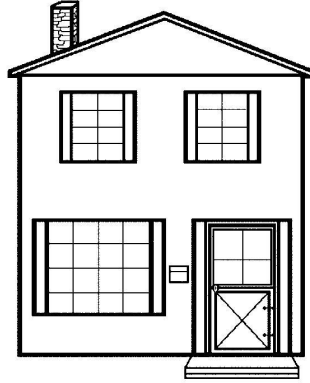
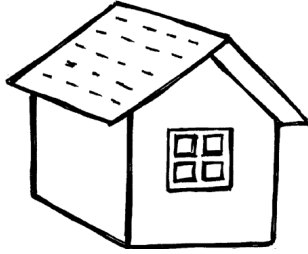

صل كل زوجين من الجوارب مع بعضهما.



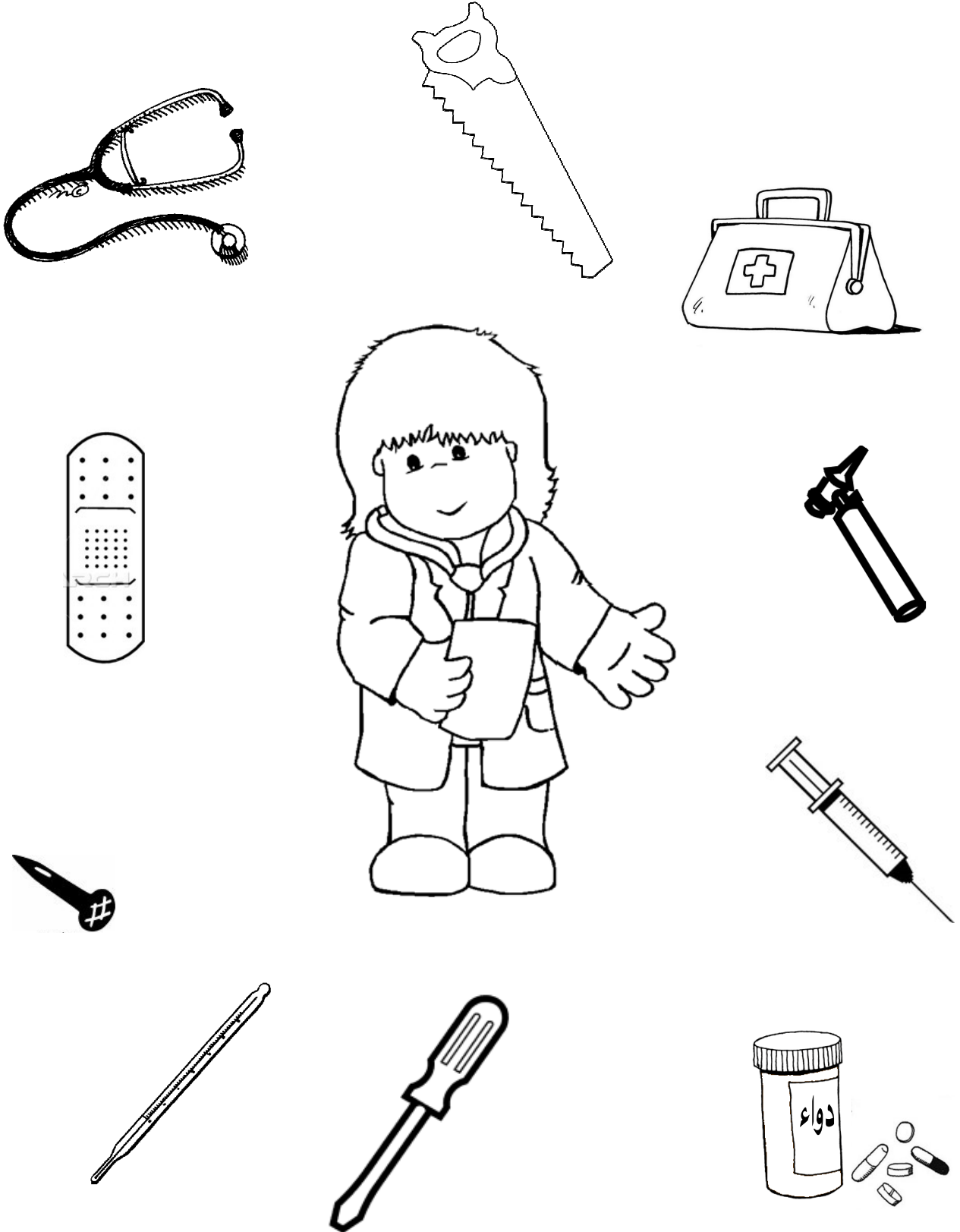

أكمل تلوين عقد اللولو كما هو موضح.

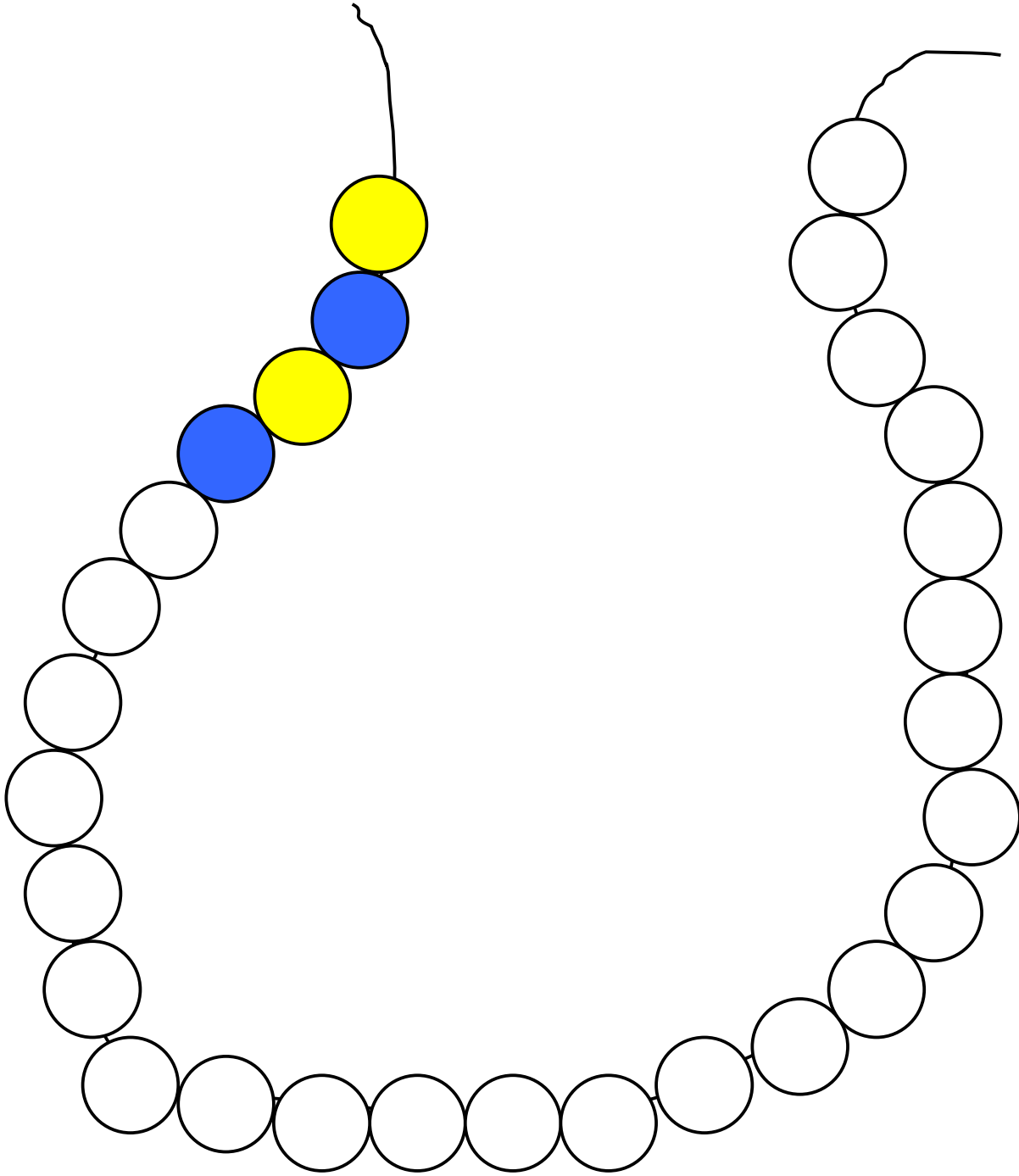

خطط على الخطوط المنقطة لتكمل صورة الزهرة.

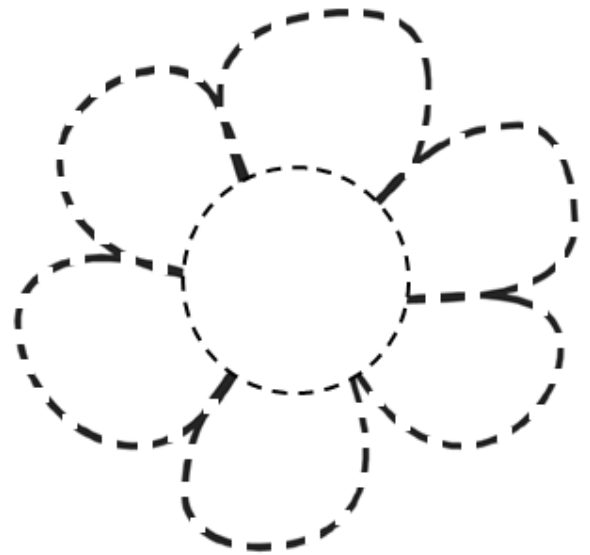
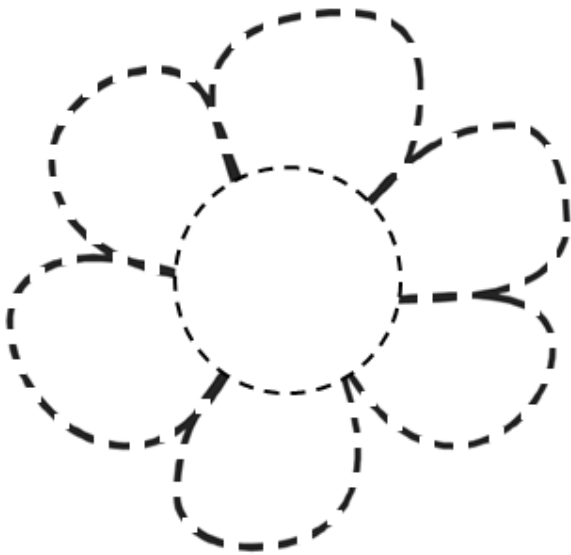
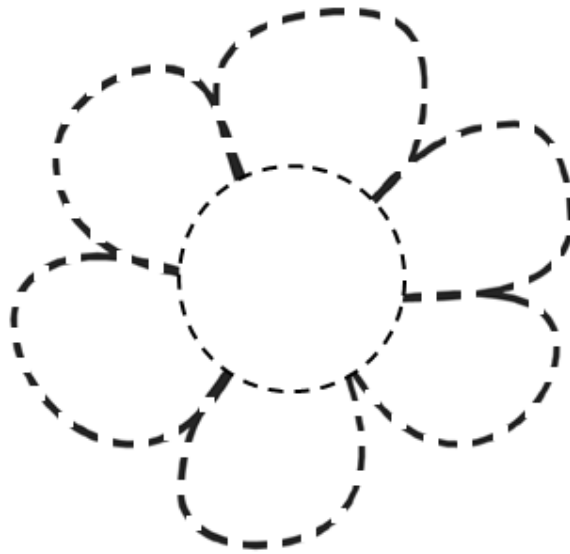
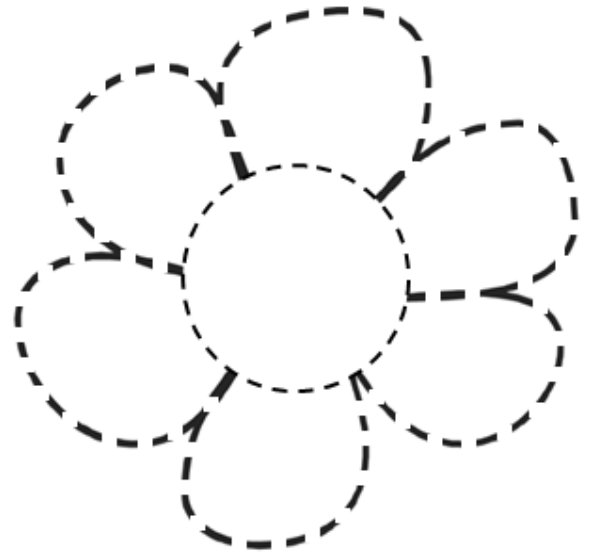
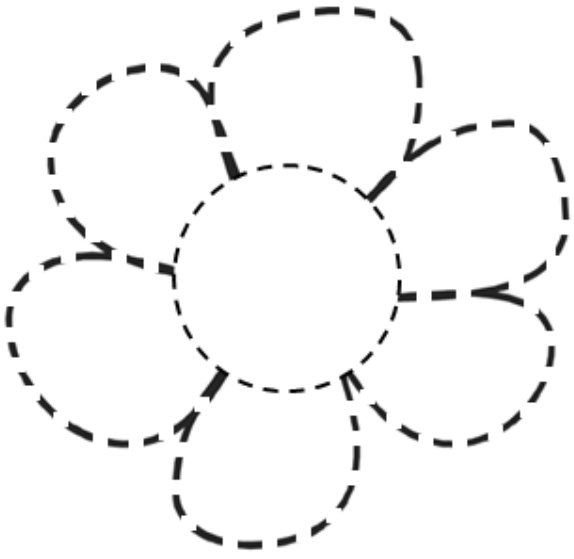

قص الأشكال المطابقة لهذه الأشكال من صفحة القصصات وألصقها على الشكل المطابق لها.
تسهيلا على طفلك، قومي بوضع الصمغ على هذه الأشكال وهو يقوم بوضع الشكل المطابق لها عليها.

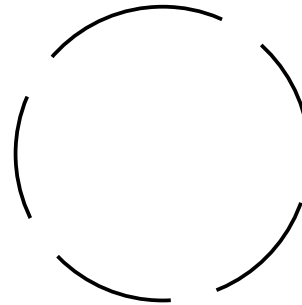
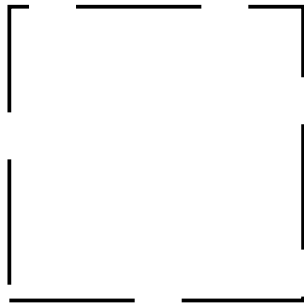
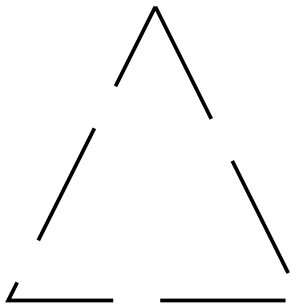
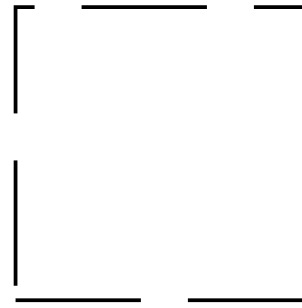
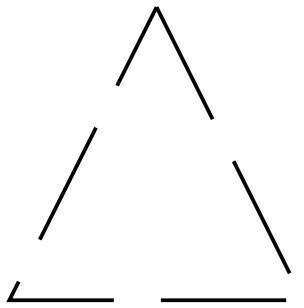
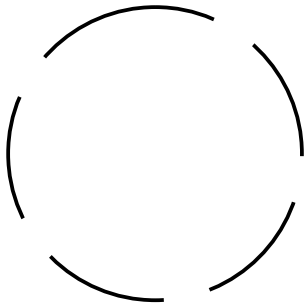
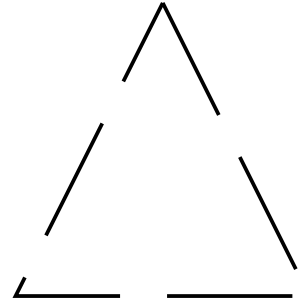
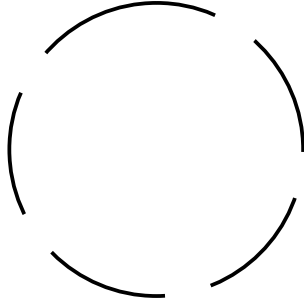
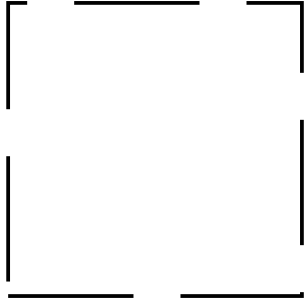

صل وسيلة المواصلات بالمكان المناسب لها.

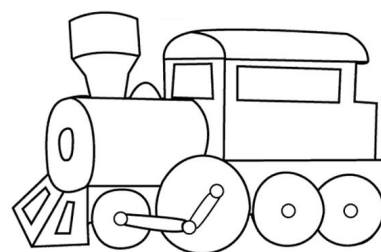
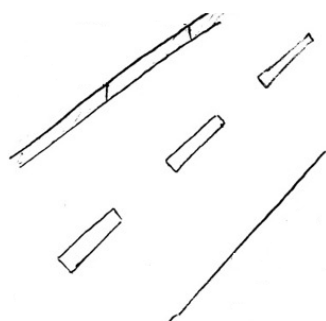
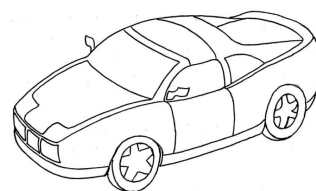
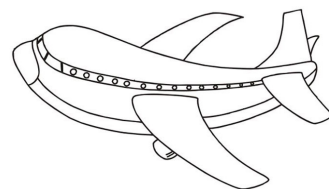
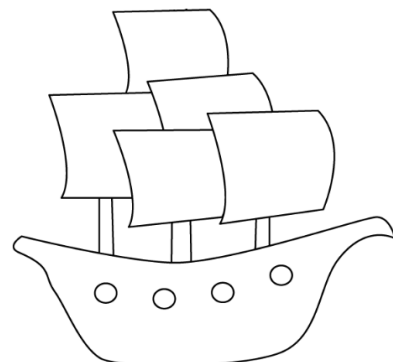
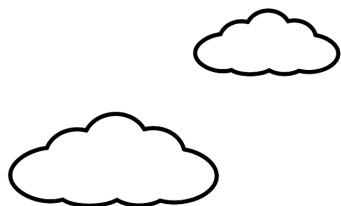

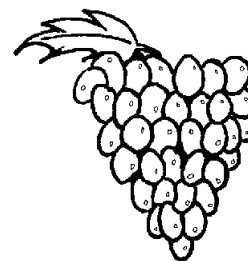
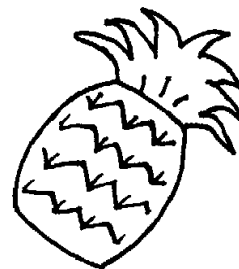
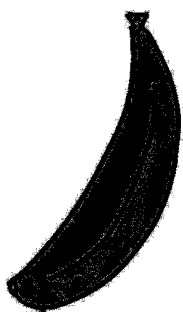
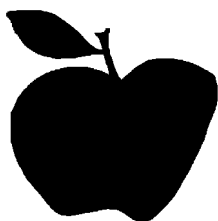
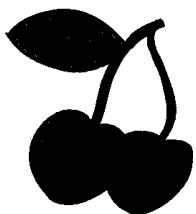
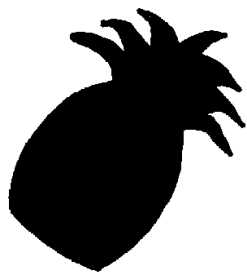

الصق أو ارسم ما تراه في السماء ليلاً ونهاراً حسب الصورة المناسبة. استخدم القصاصات

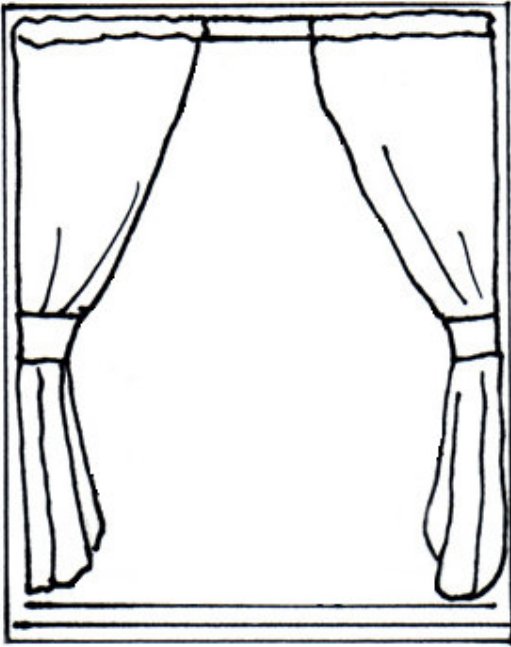
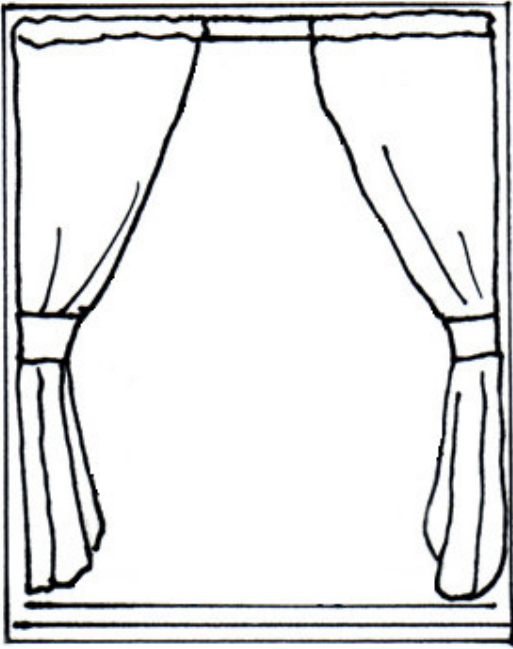

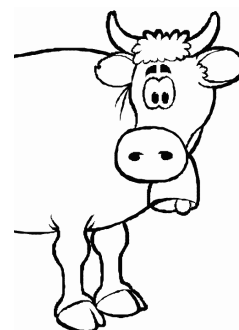
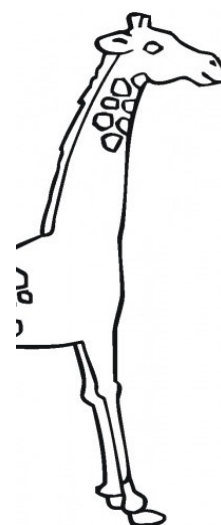
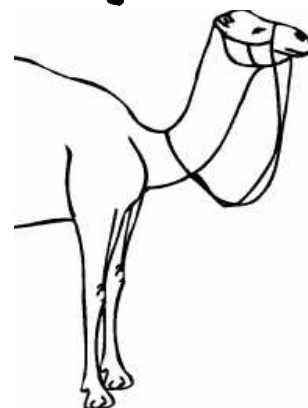
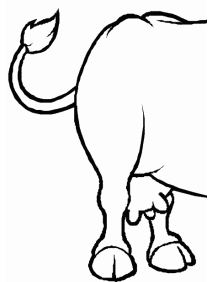

حوط ملابس البنت باللون الوردى وملابس الولد باللون الأزرق.

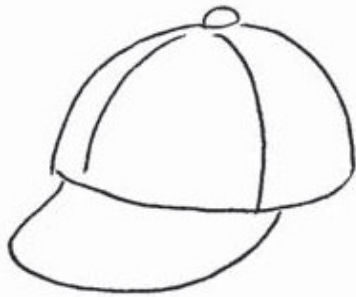
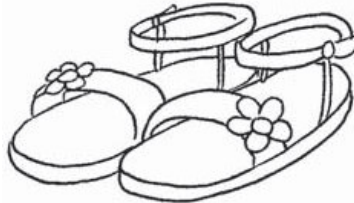
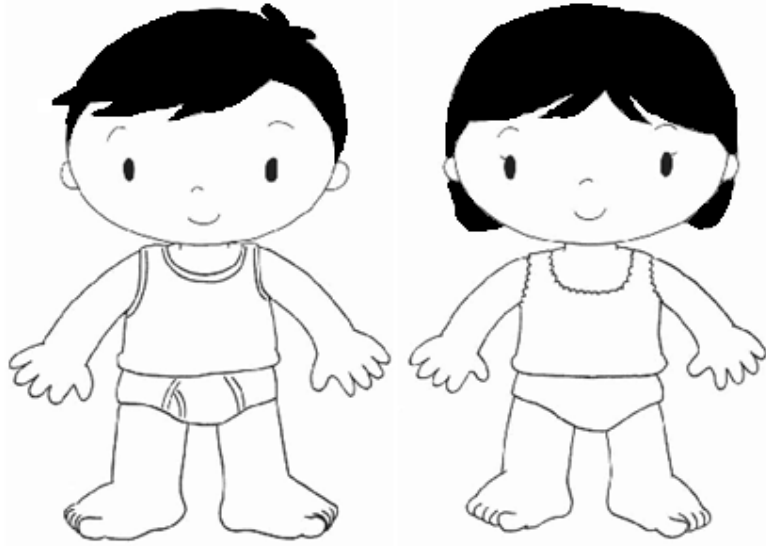

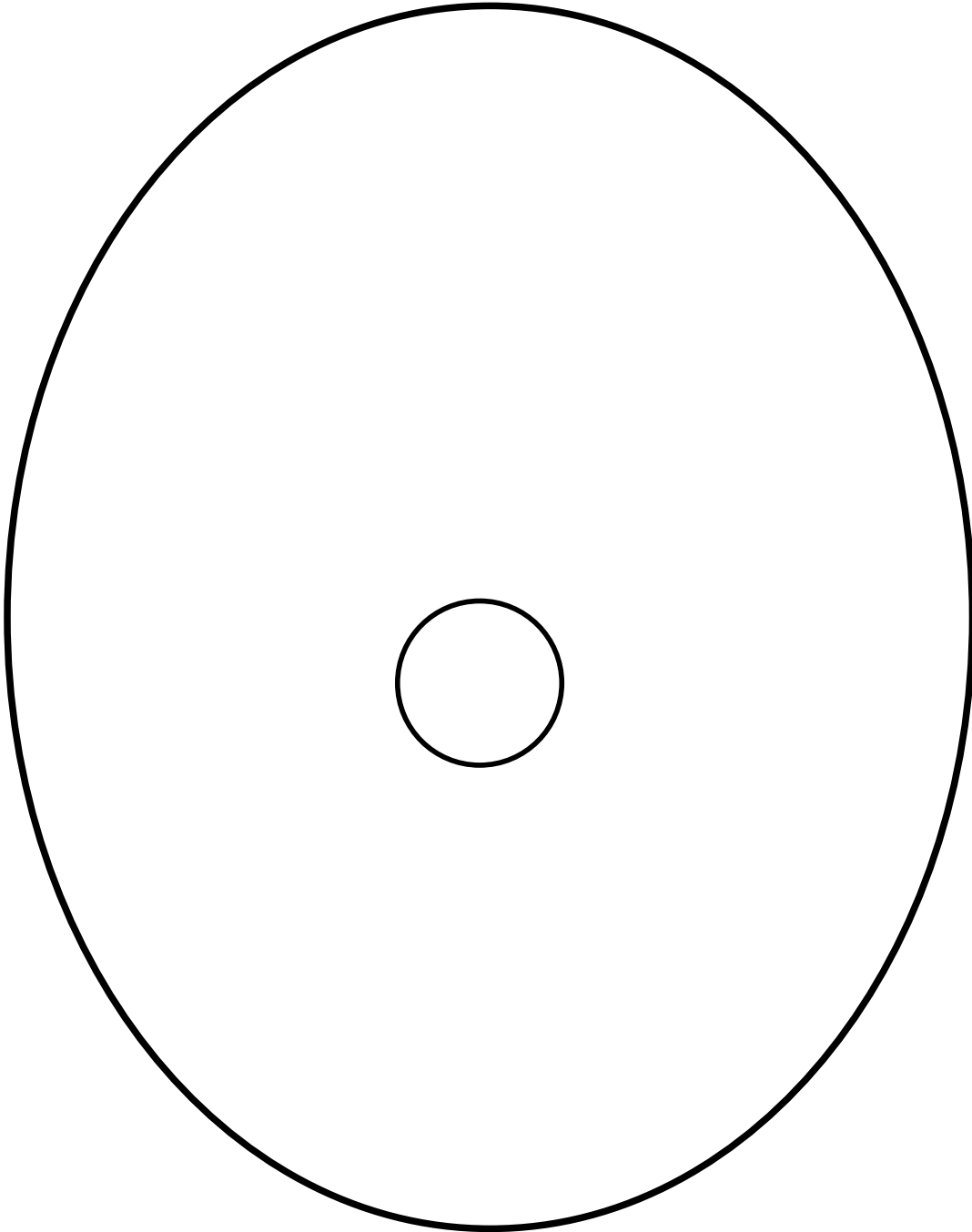

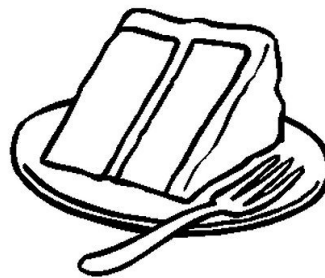
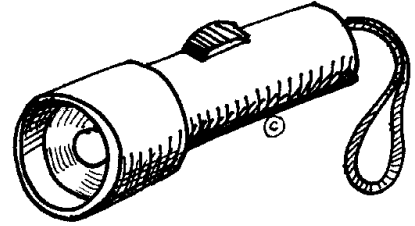
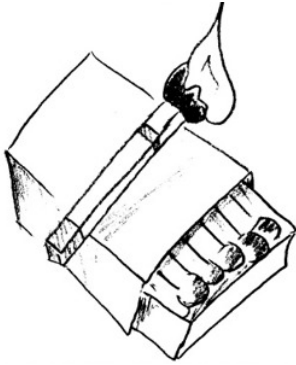
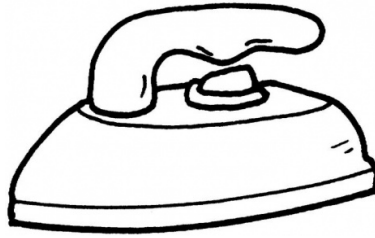
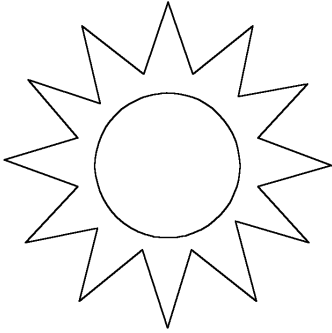

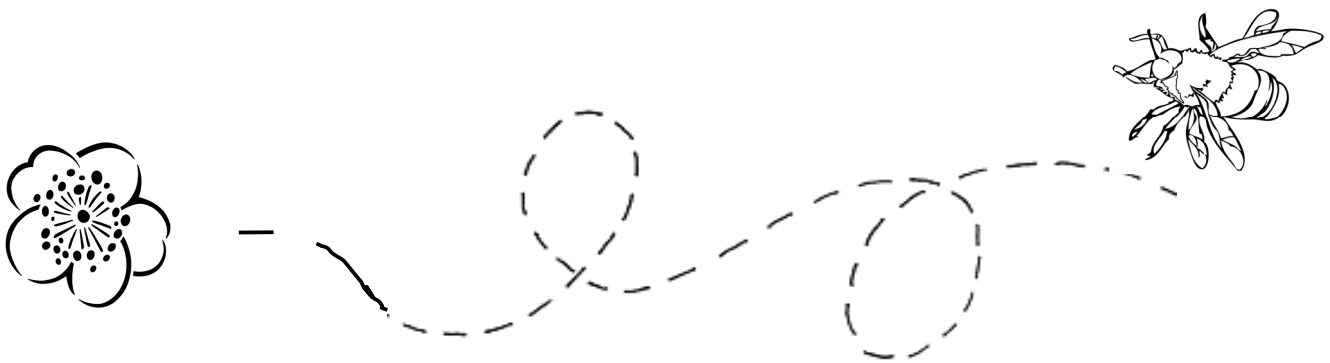
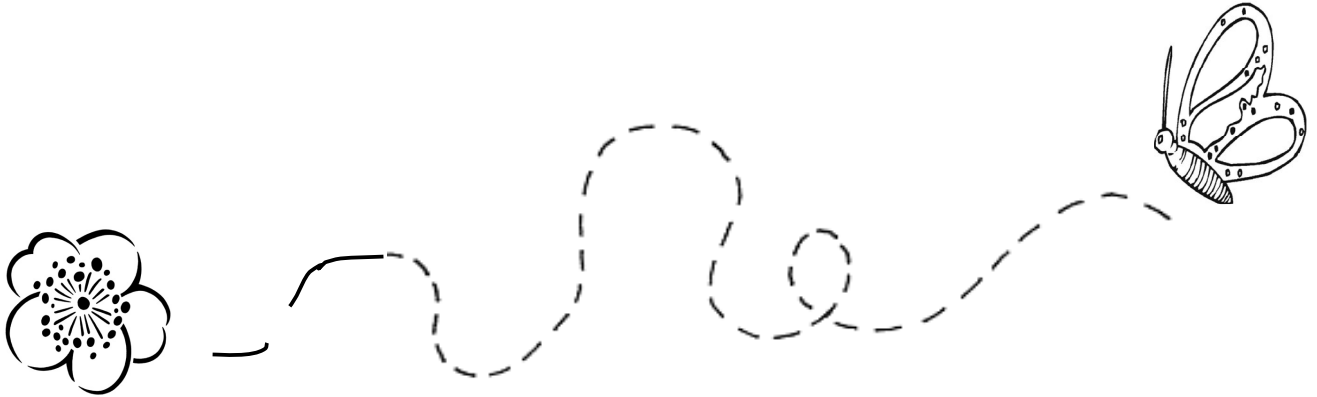

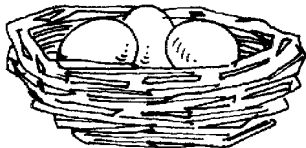
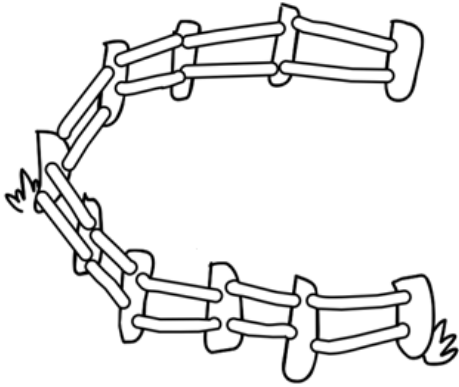
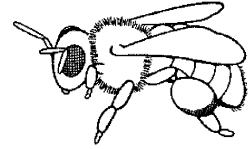
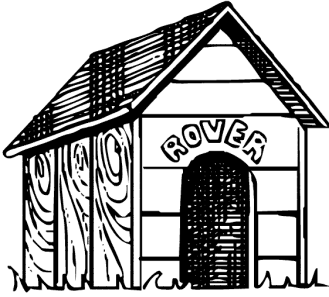
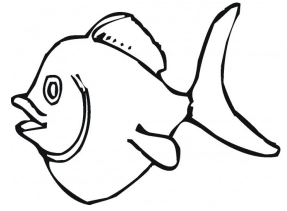

ساعد أحمد في البحث عن أدواته المدرسية. ارسم دائرة حولها.

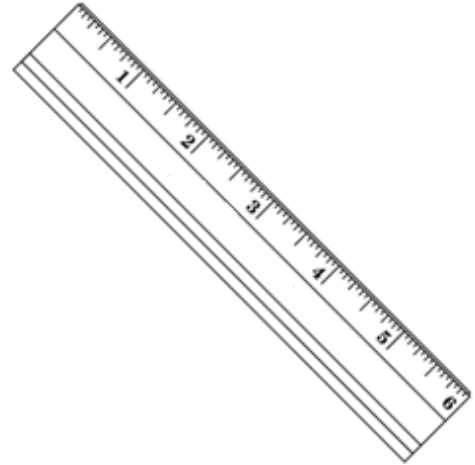
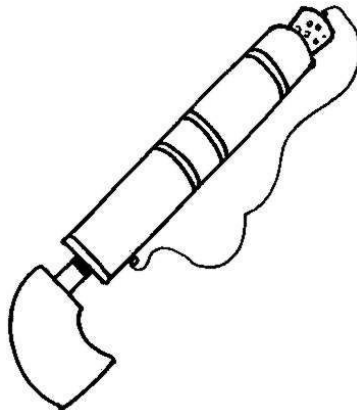
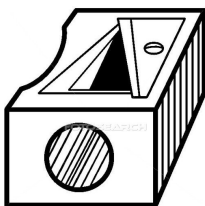
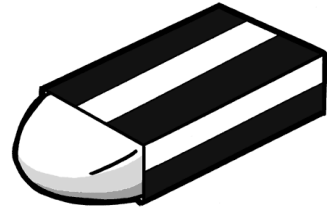
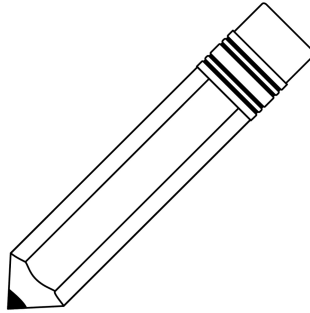
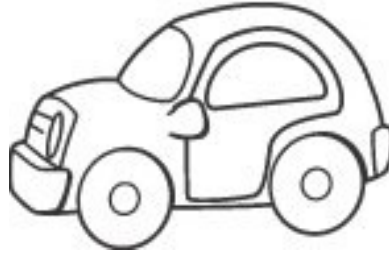
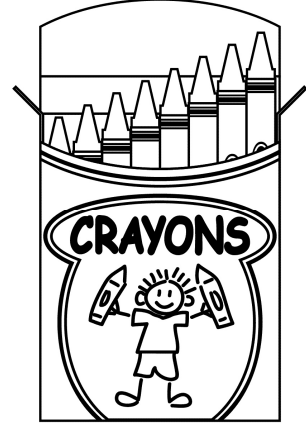

ليصنع فلك دوائر على الدوائر الموجودة حالياً في حبة الفراولة الأولى باستخدام أعواد تنظيف الأذن بعد أن يضع ريف العود القطني في معجون الألوان. ويكمل على بقية حبات الفراولة.

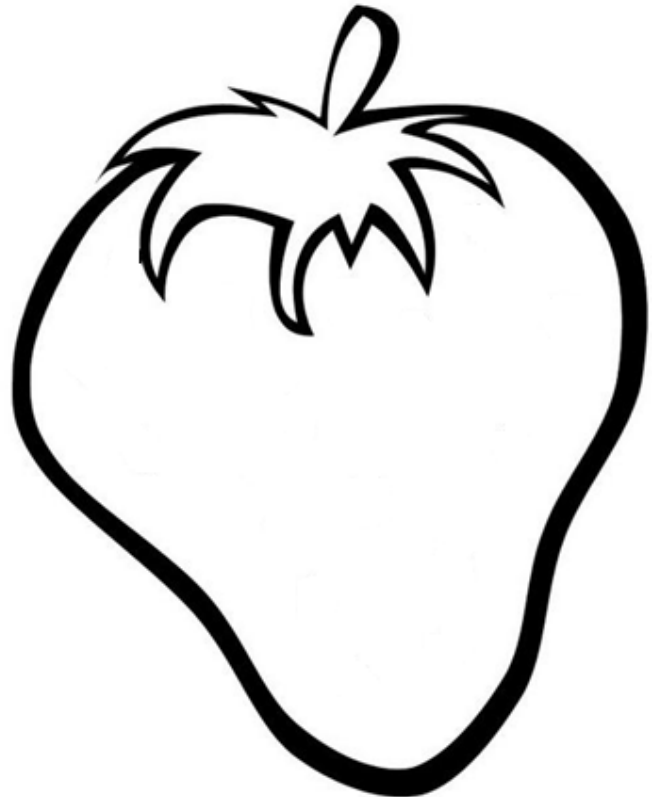
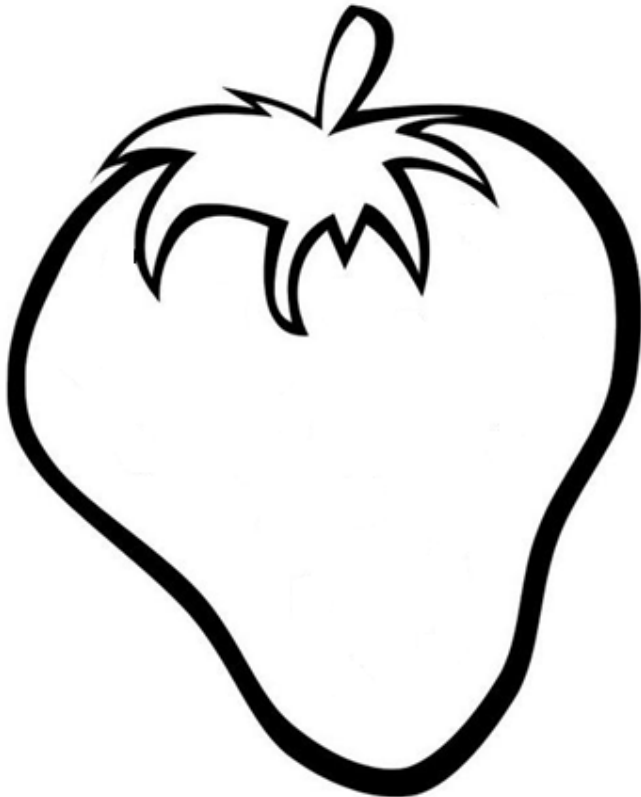
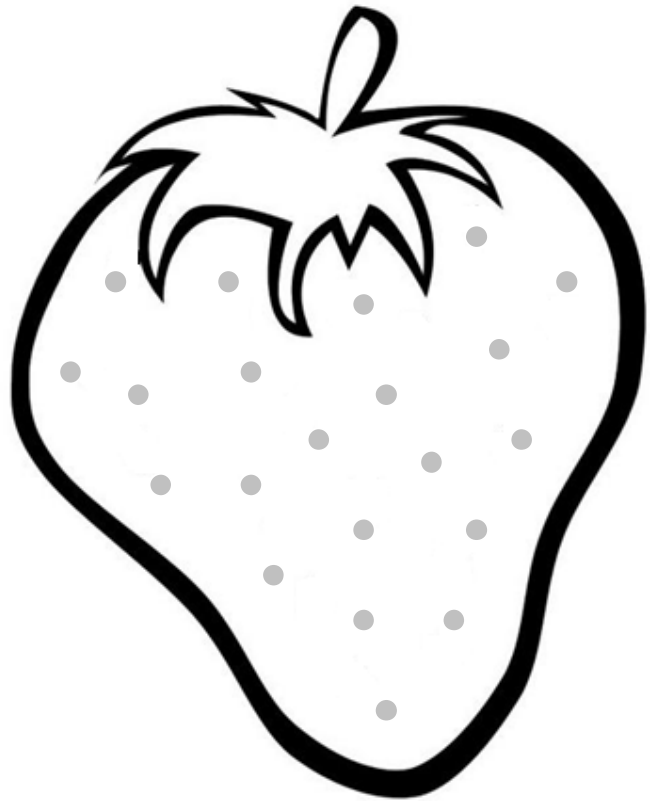
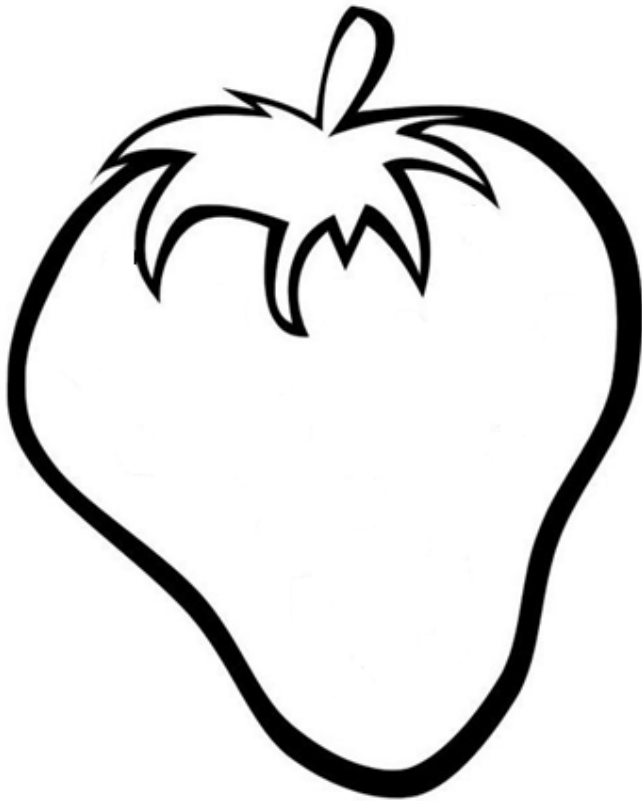

أكمل رسم السلم. خطط.

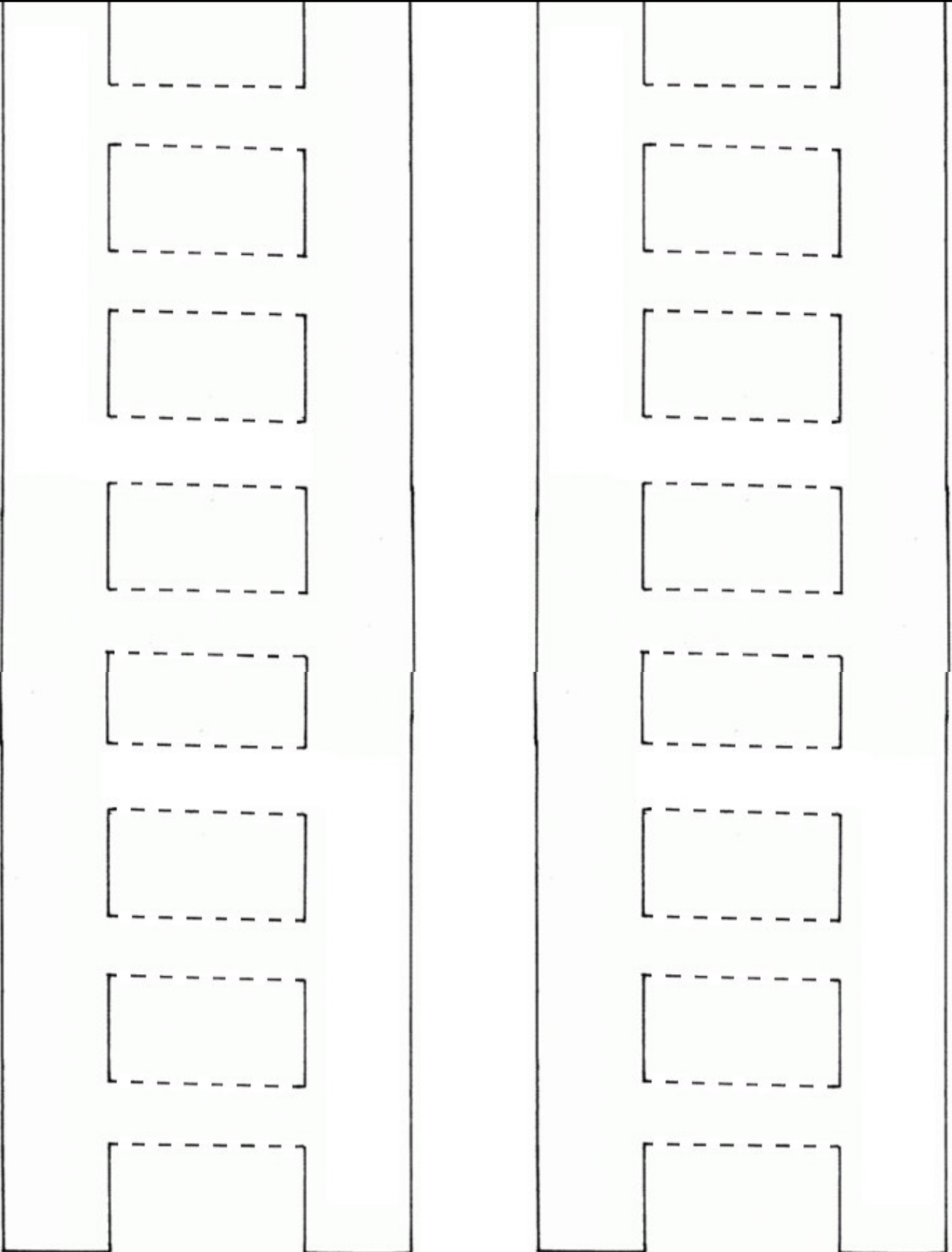

لماذا وسيم حزين؟ حوط إجابتك.

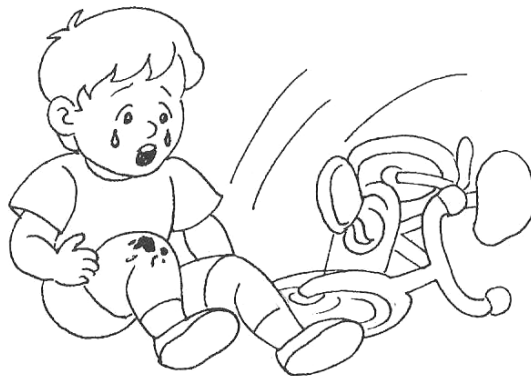

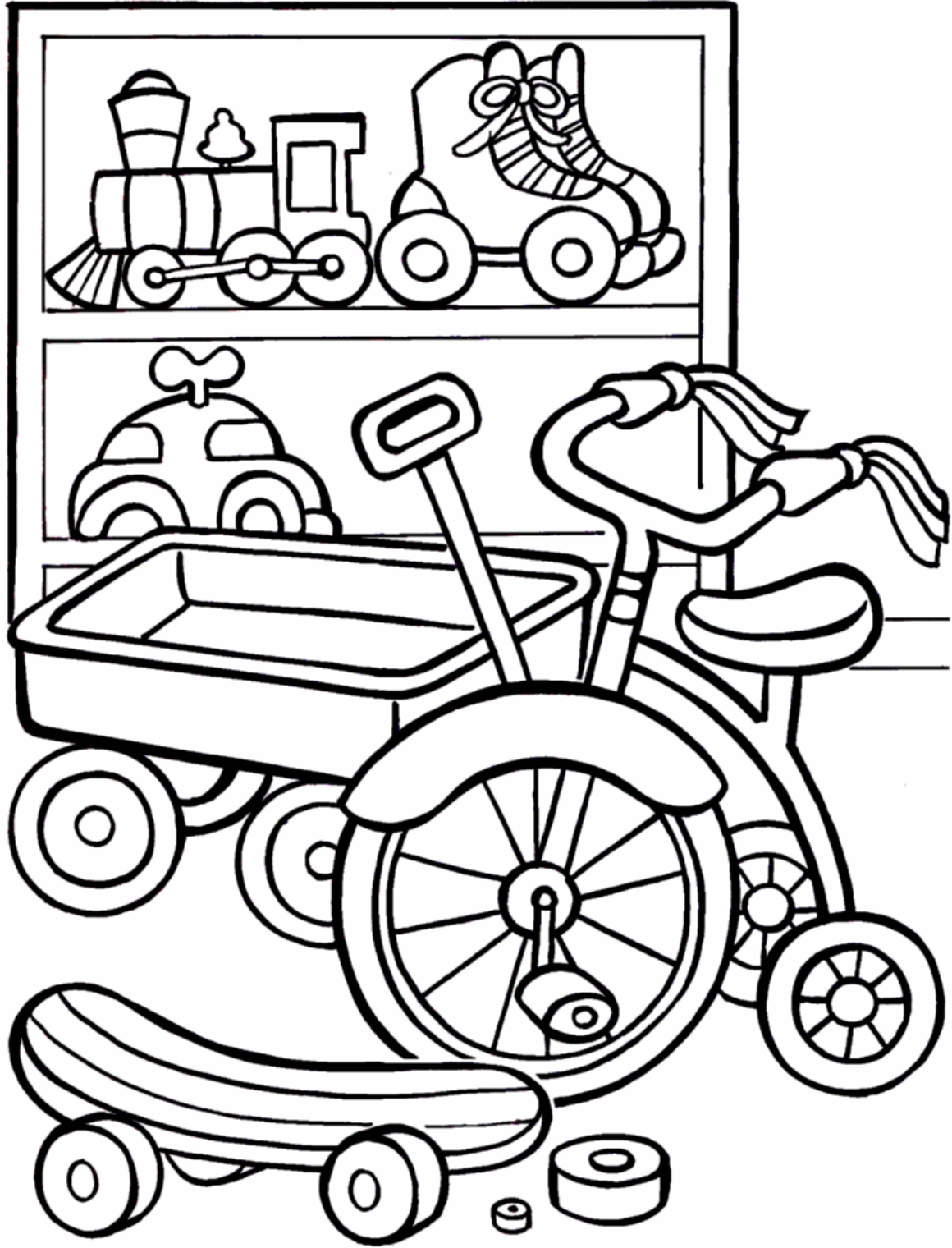

ما سبب فرحة سعاد؟ حوط إجابتك.

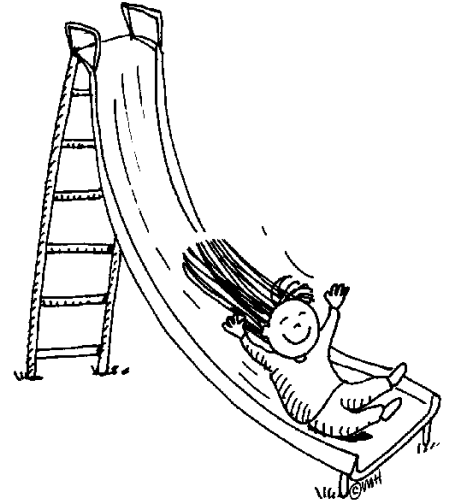
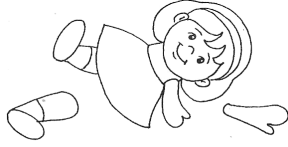

صل الصورة بالجزء المفقود منها.

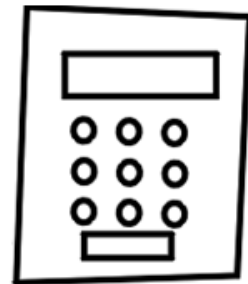
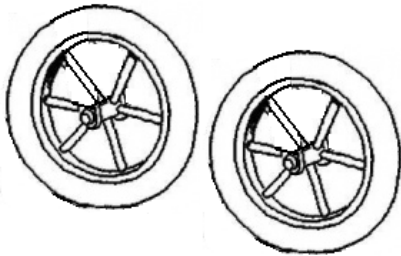
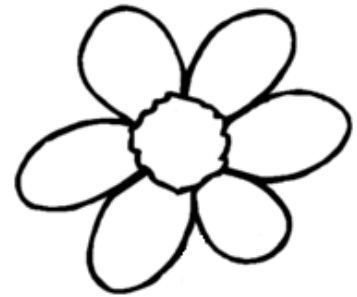
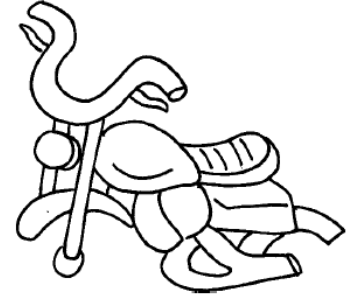

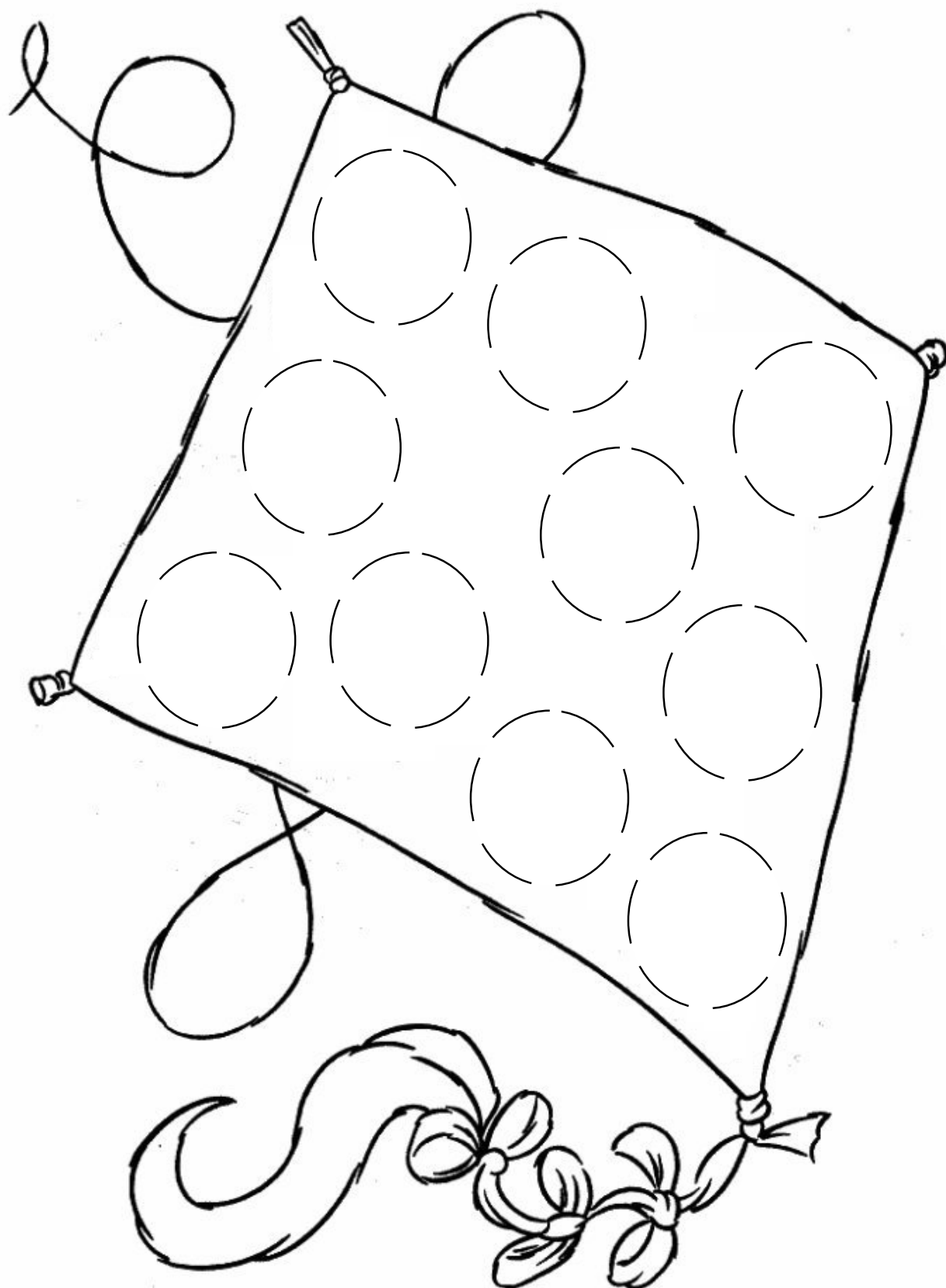

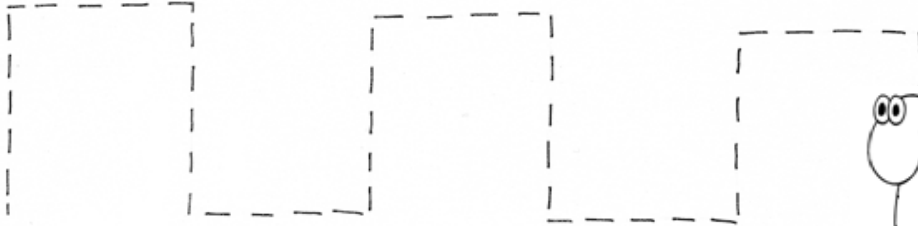
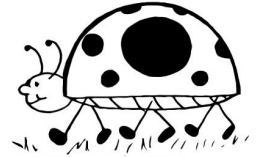
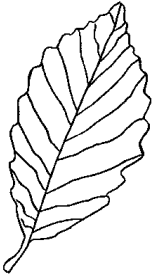
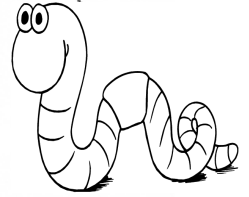

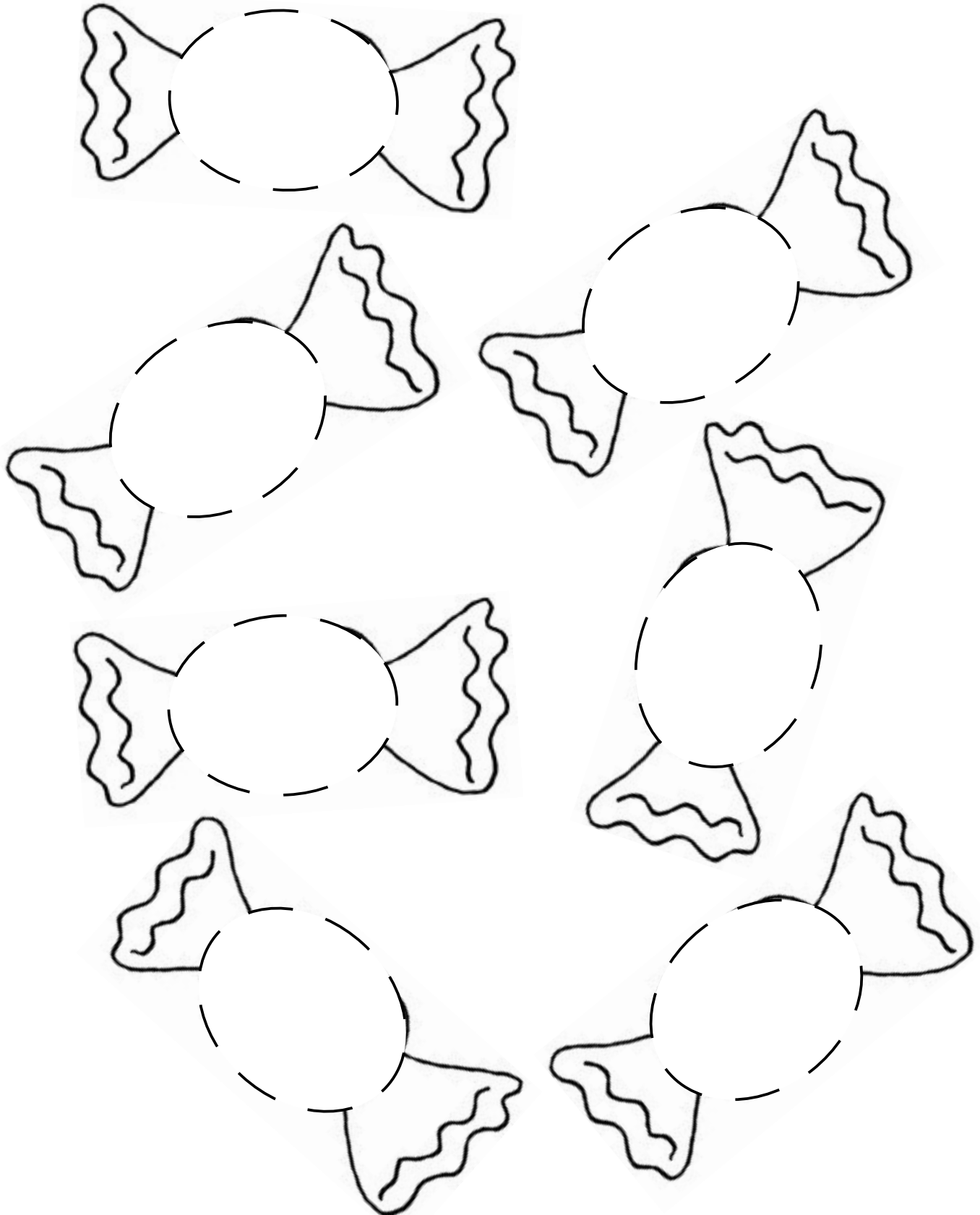

صل كل فردة من الحذاء بالأخرى .

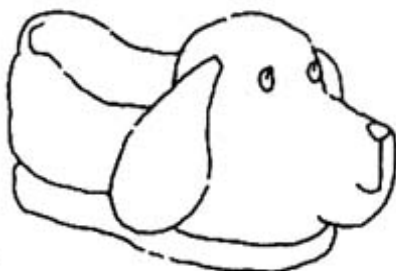
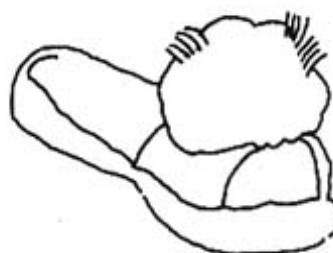
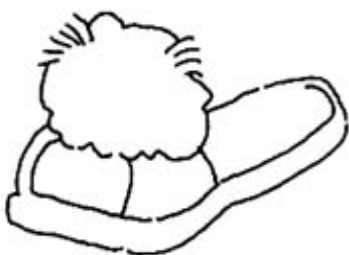
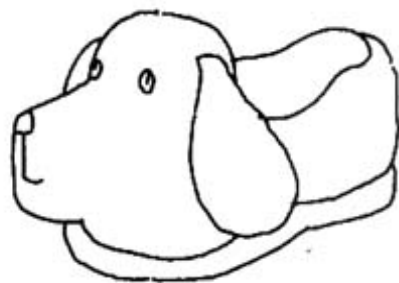

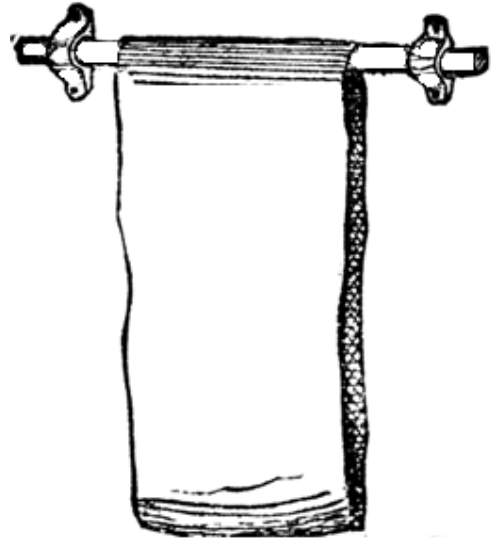
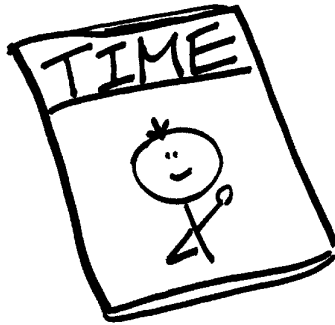

الصق صور السمك في الحوض ولونها بألوانك المفضلة. من صفحة القصصات

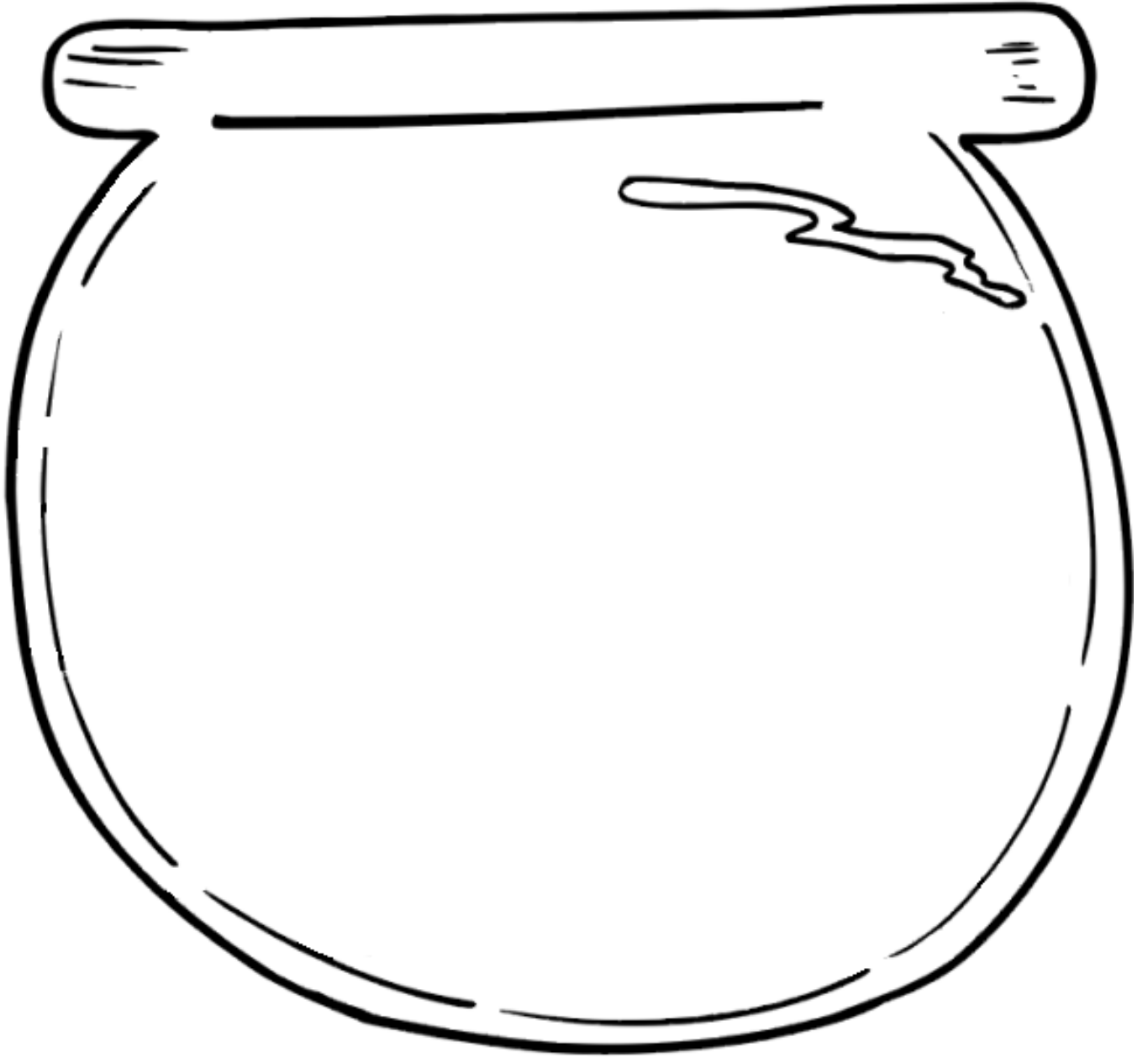

صل الصورة بالجزء المفقود منها.

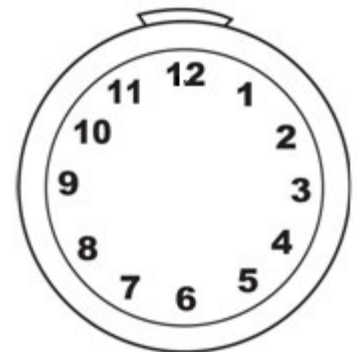
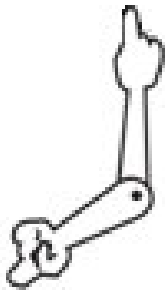
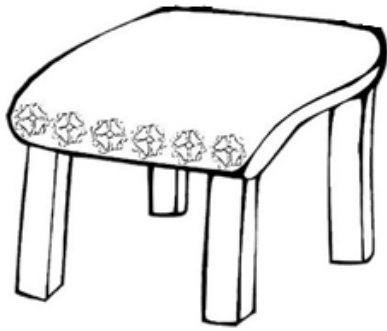
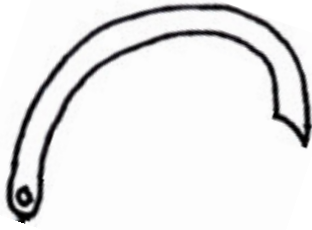

للحيوانات فوائد عديدة، صل الحيوان بما نستفيد منه.

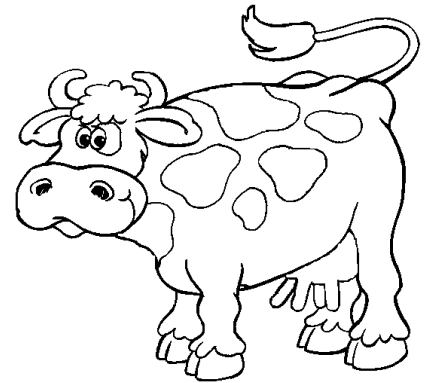
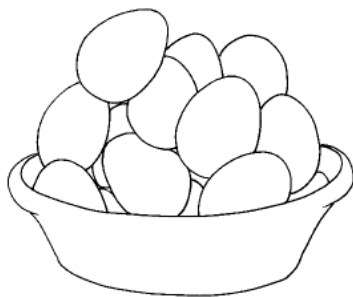
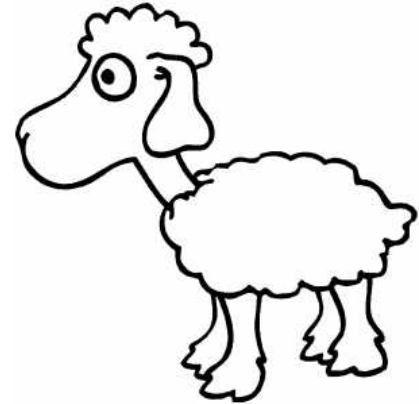
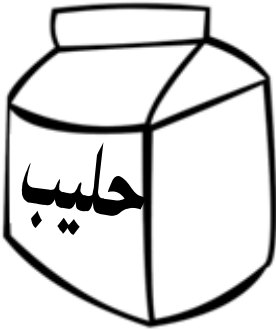
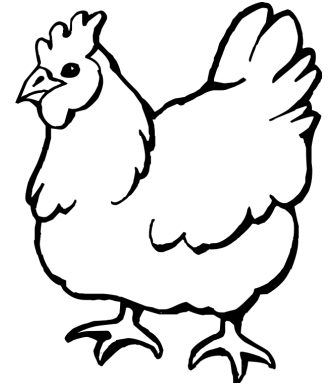
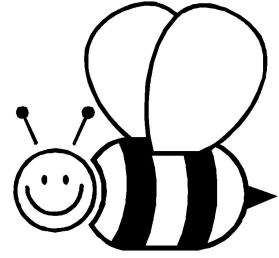
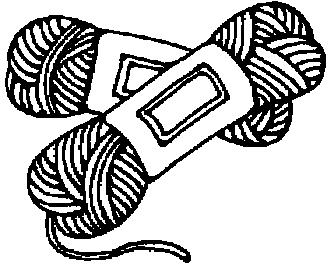

أكمل التلوين كما هو موضح.

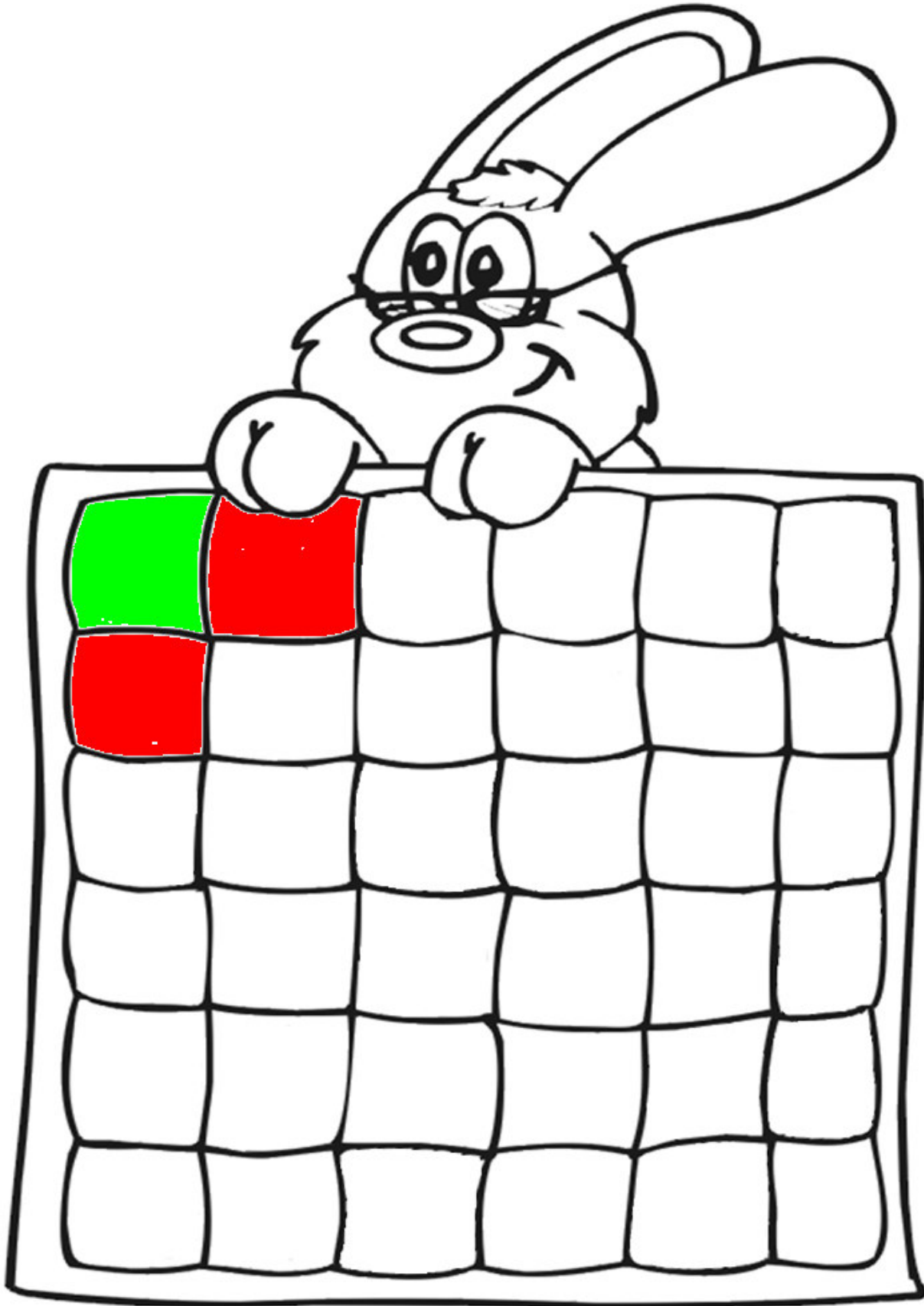

صل كل شخص بالأداة التي يريدھا.

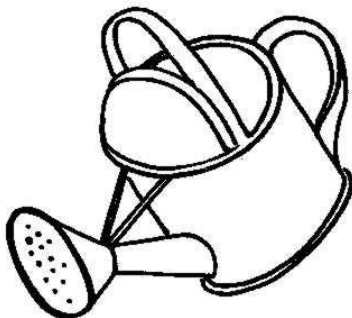
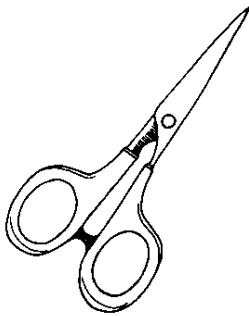
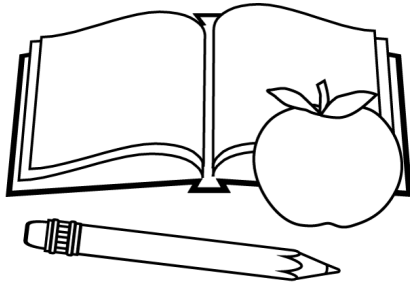

صل الصورة بالجزء المفقود منها.



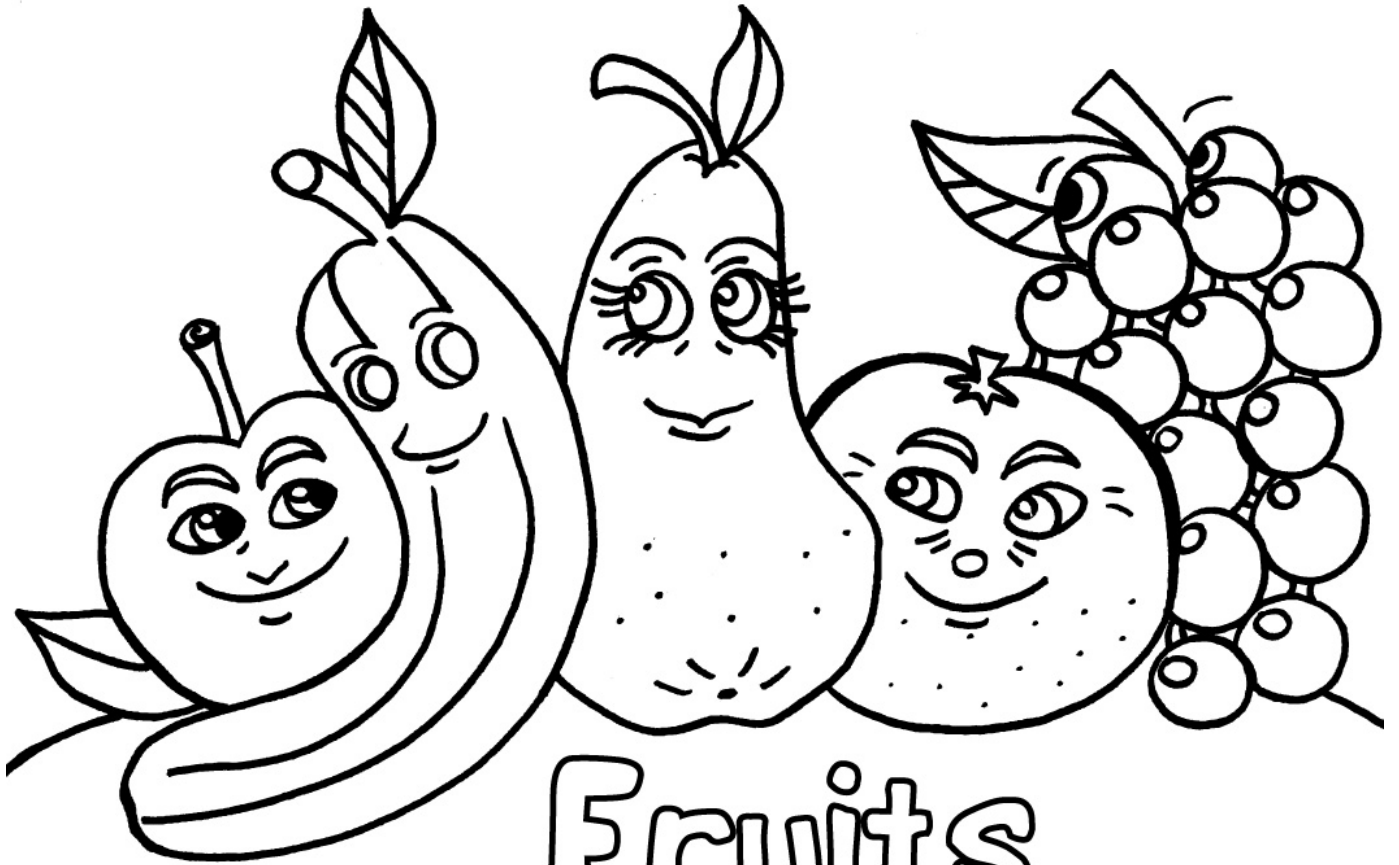

Fruits

فواكه



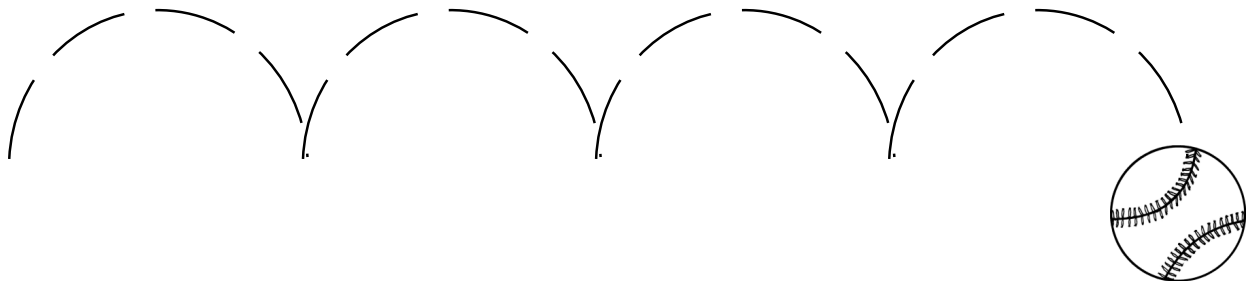
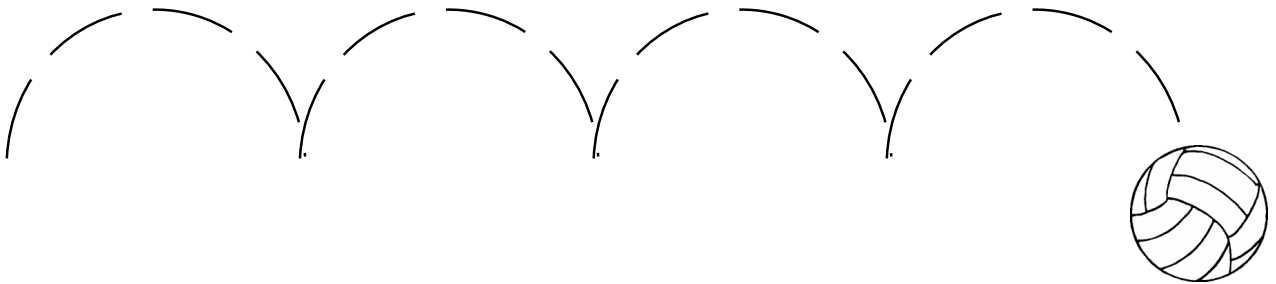
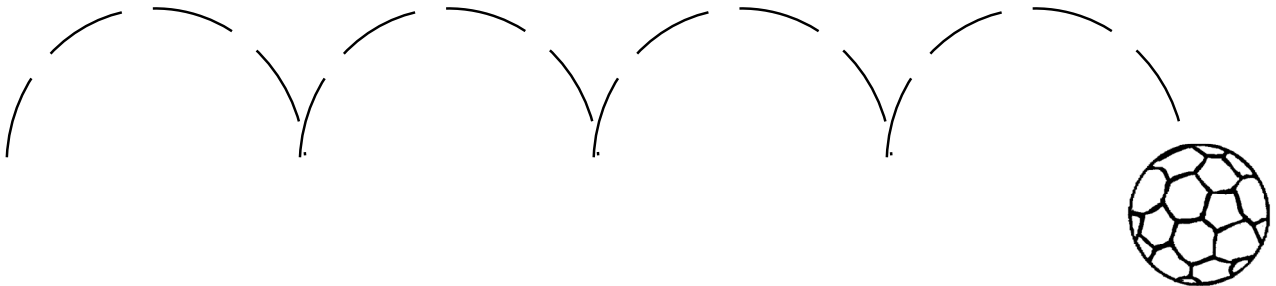
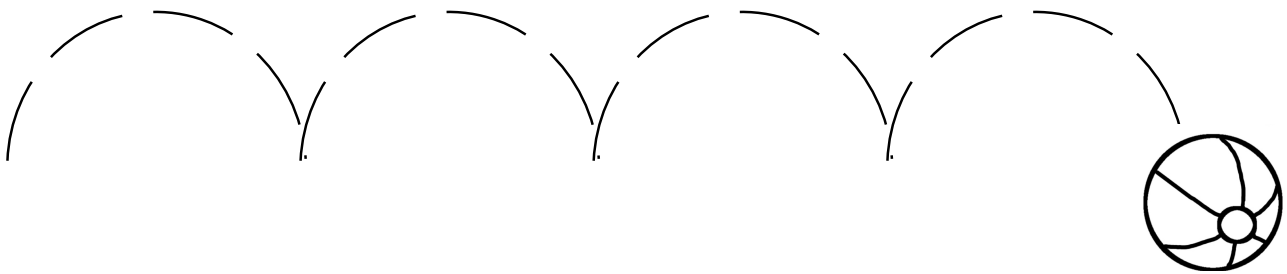
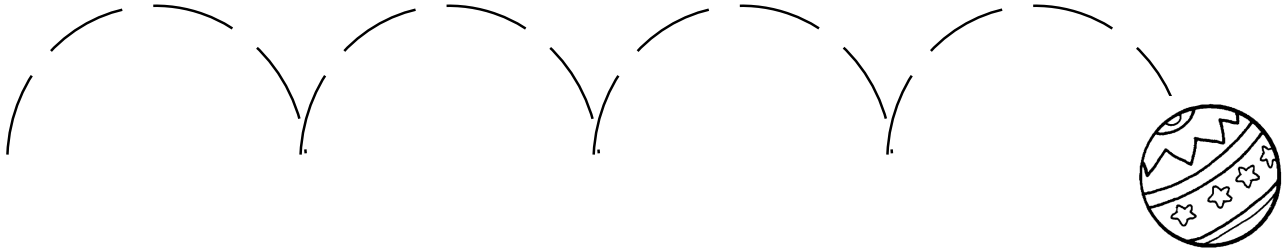

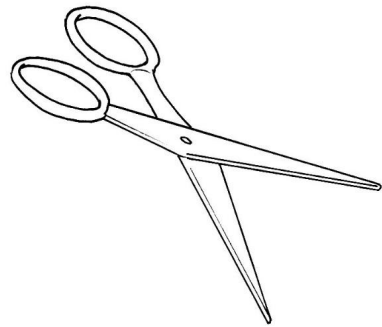
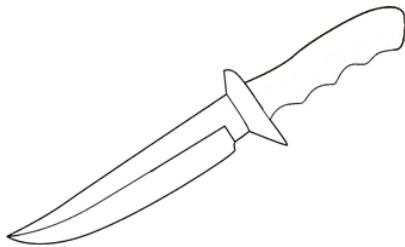
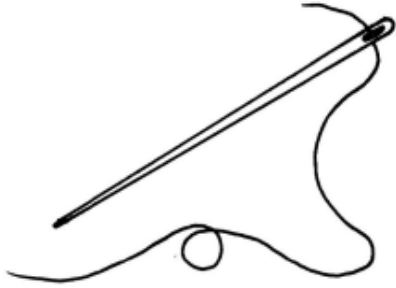
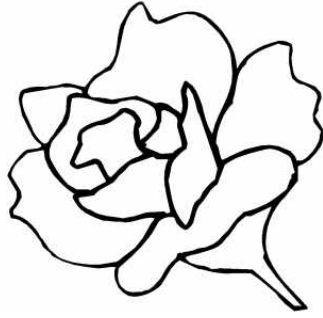
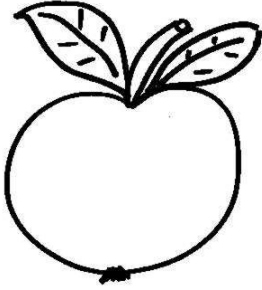

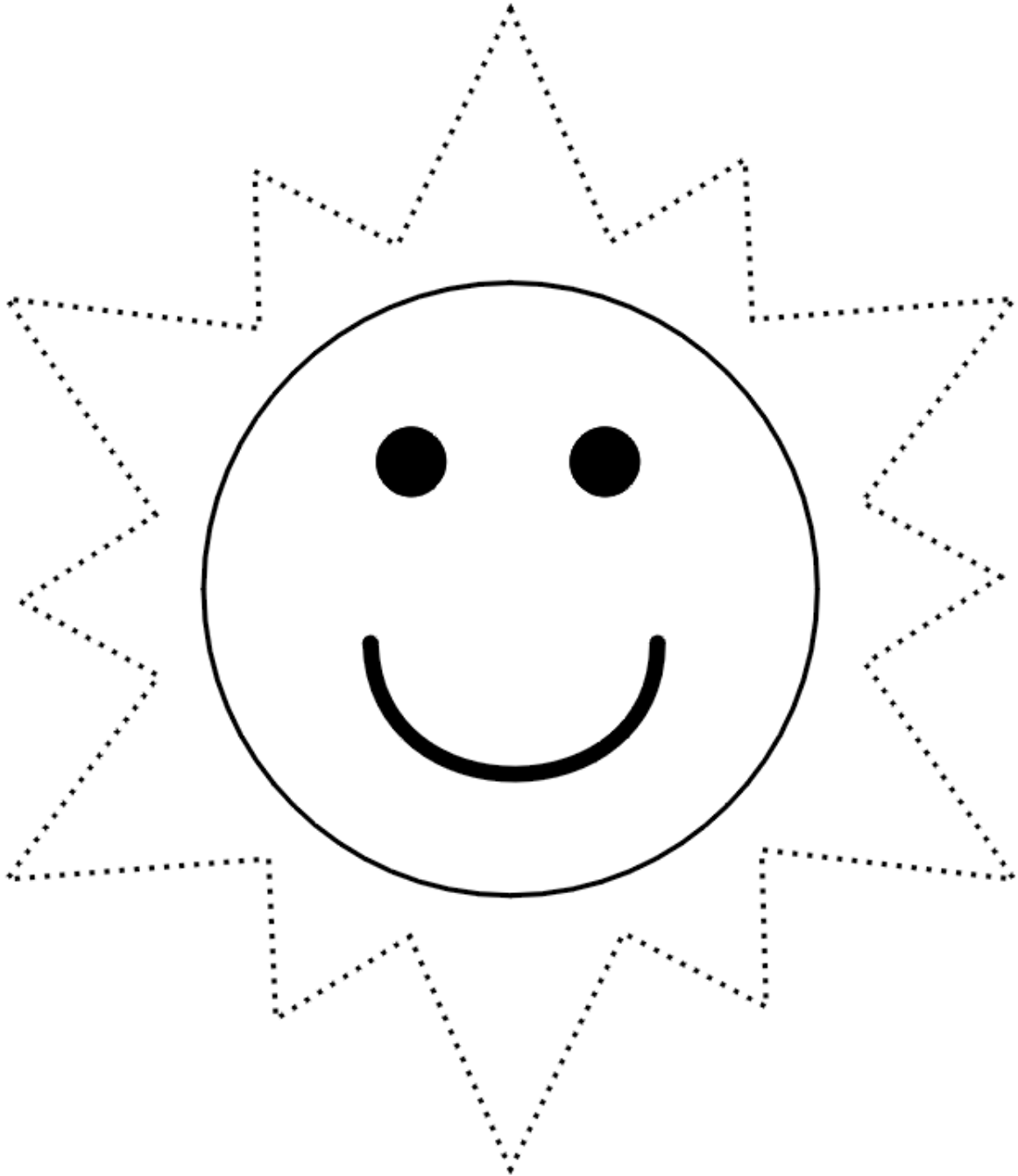

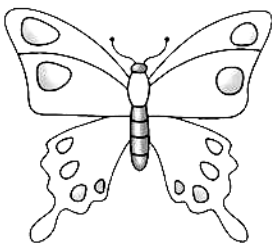
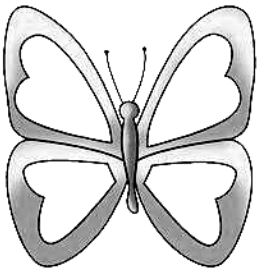
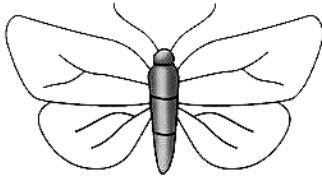
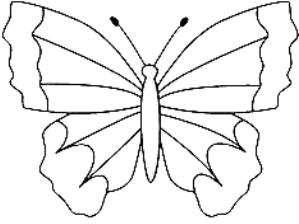

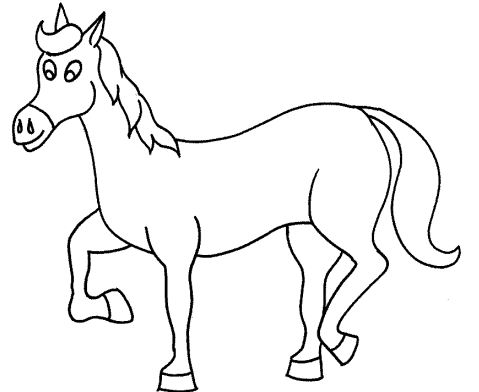
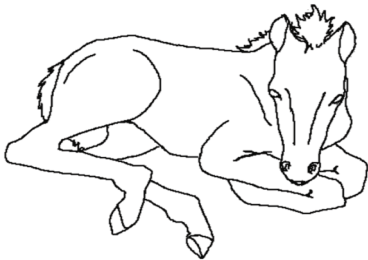
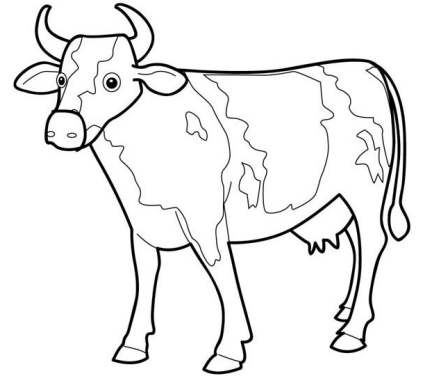
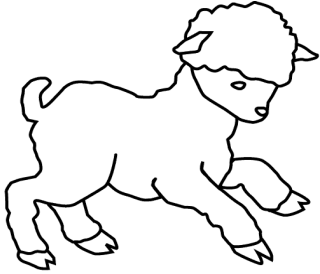
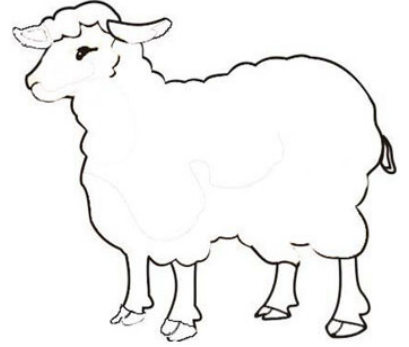
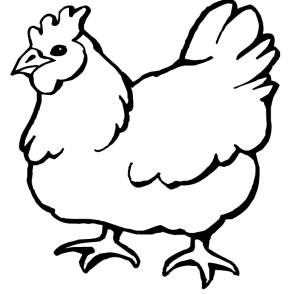
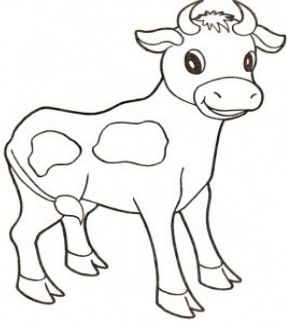

الصق الأزرار على القميص. من صفحة القصاصات.

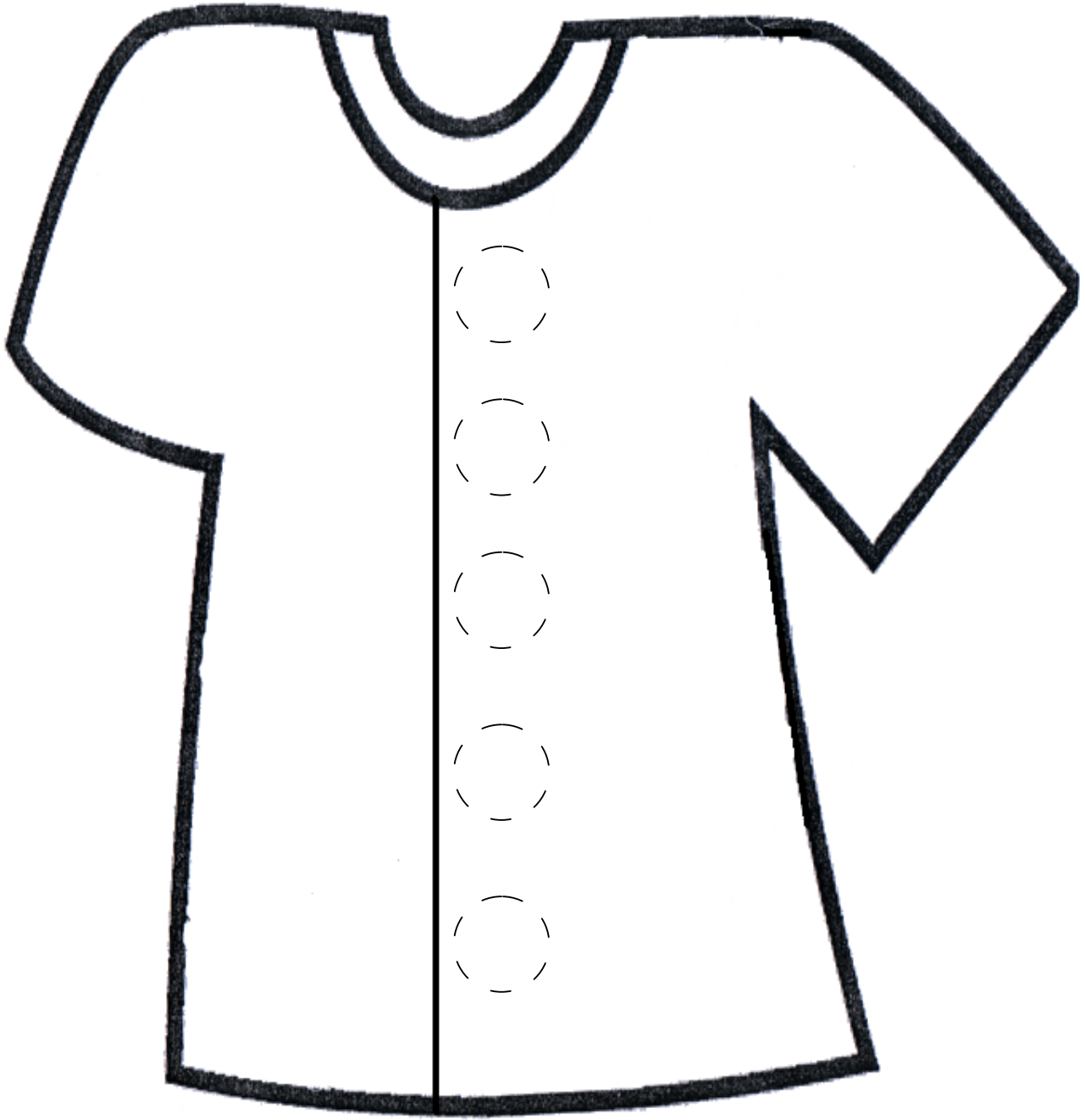

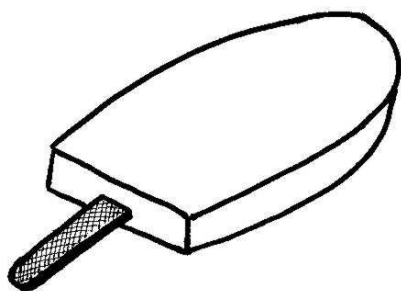
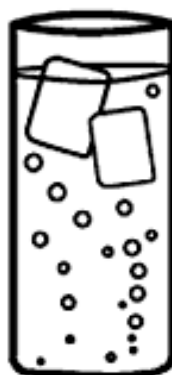

الصق التعبير المطابقة لكل وجه . من صفحة القصصات .

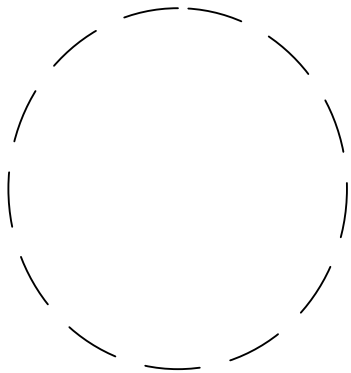
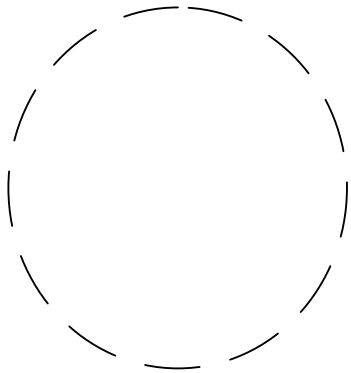
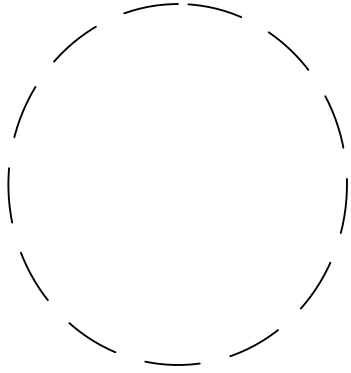
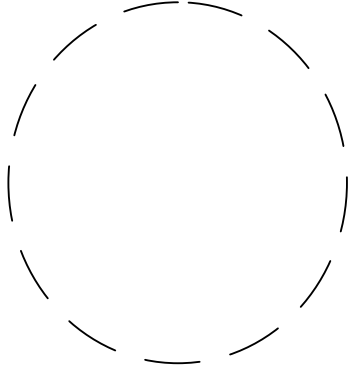

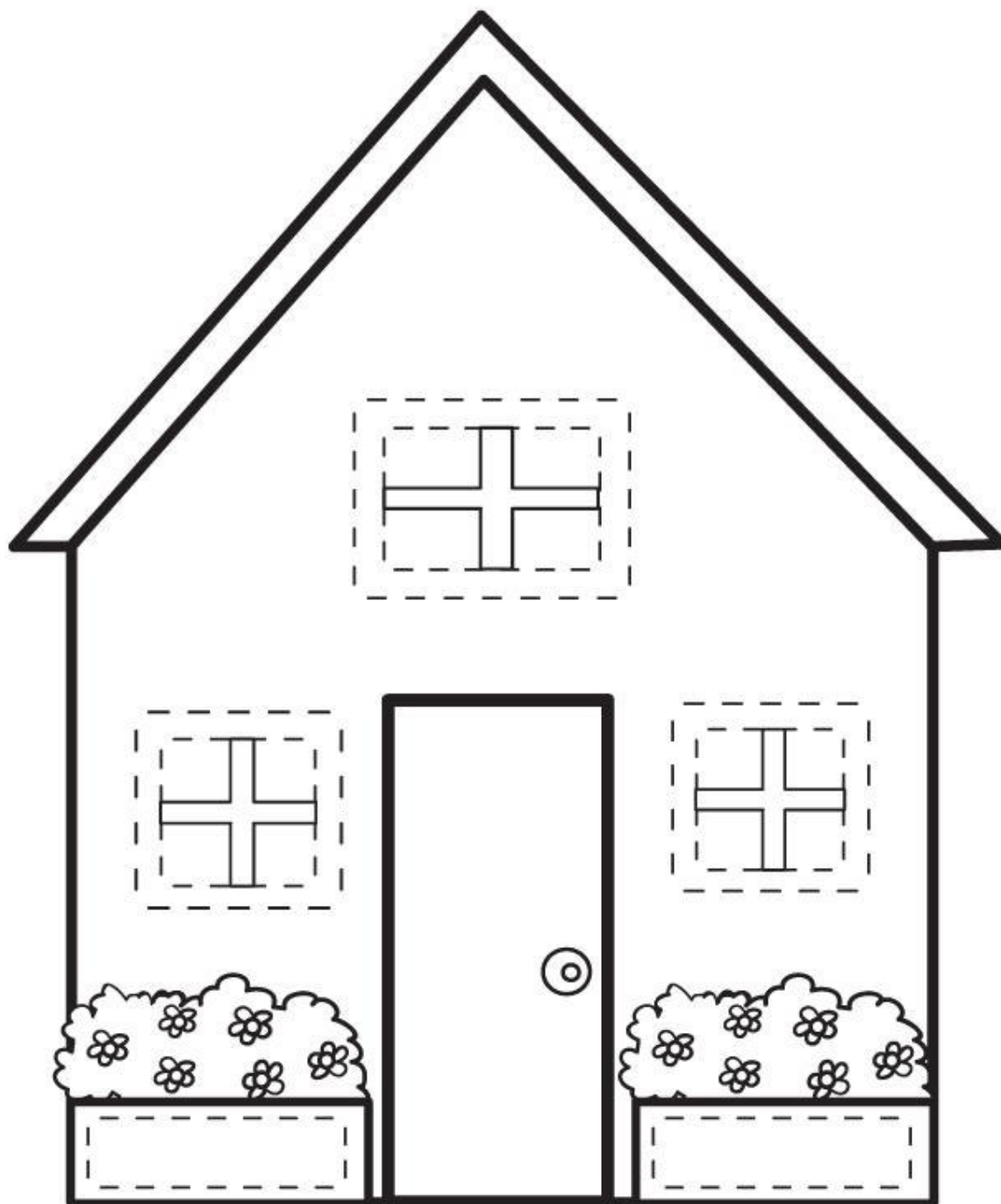

(ويل - قصير) لون القصير باللون الأصفر والطويل باللون الأخضر.

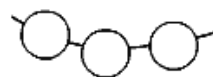
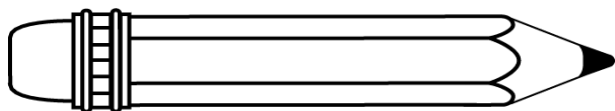
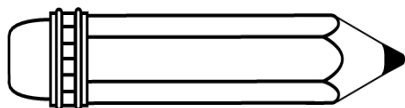
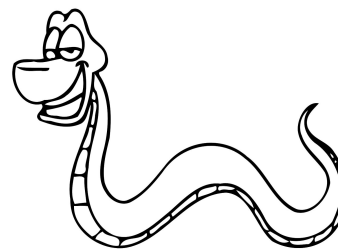
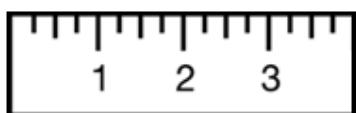
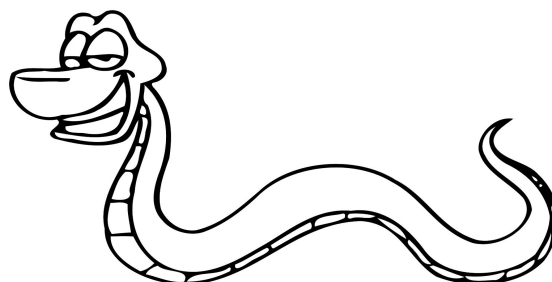
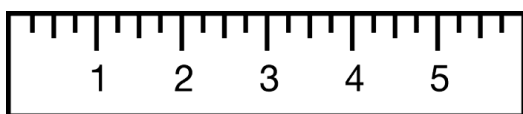

ليصنع فلك دوائر على حبات العنب وليكن بلون العنب المفضل لديه (الأصفر ، البنفسجي) باستخدام أعواد
تنظيف الأذن بعد أن يضع طرف العود القطني في معجون الألوان.

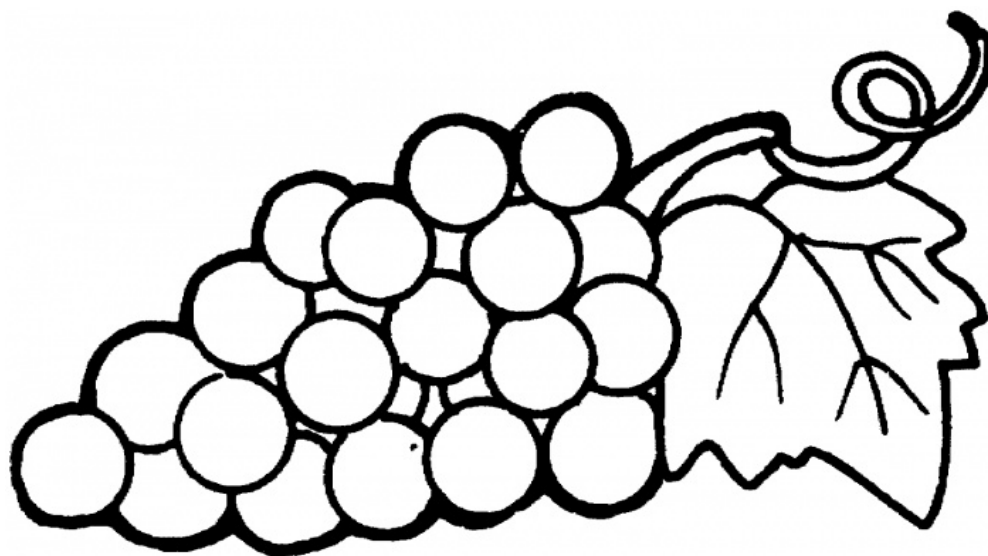
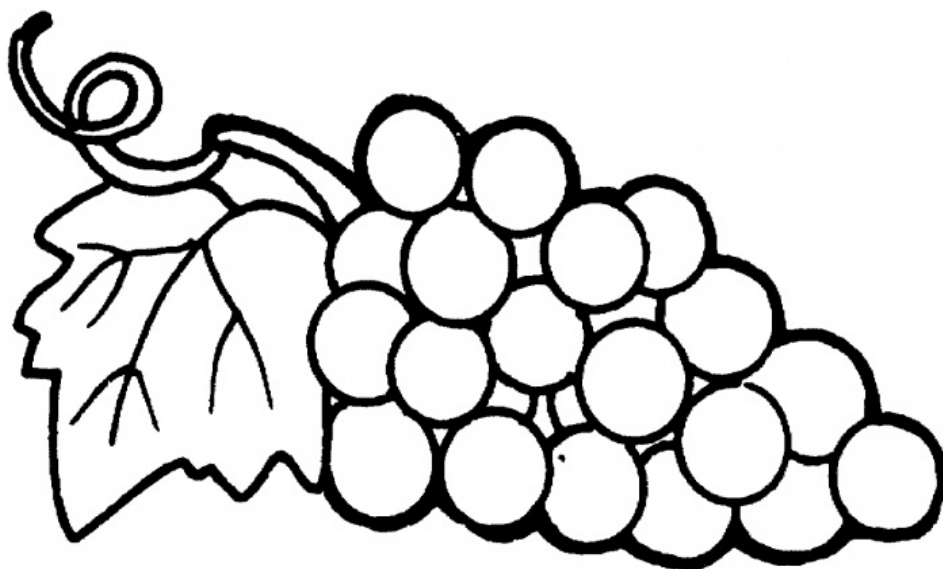

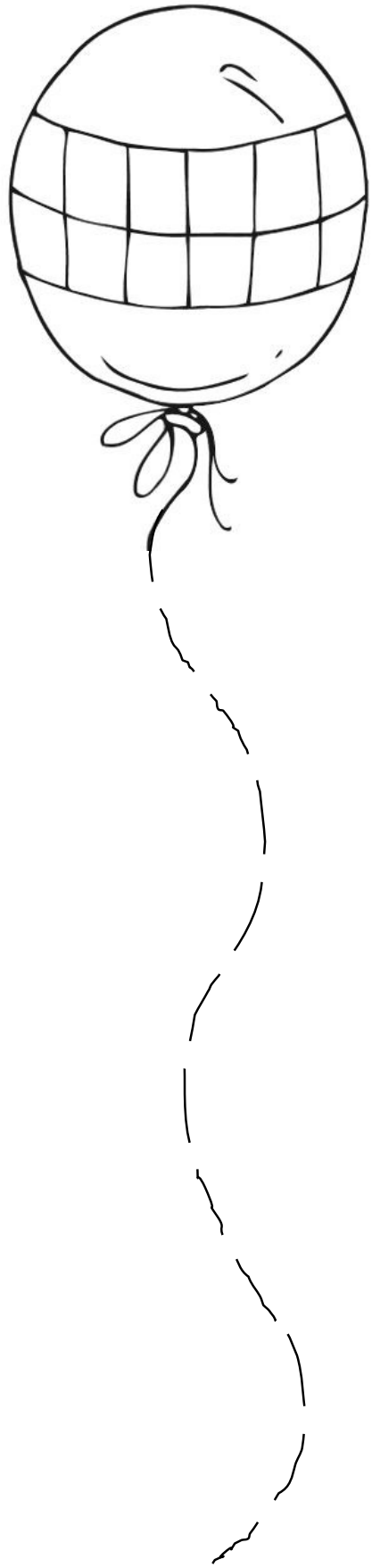
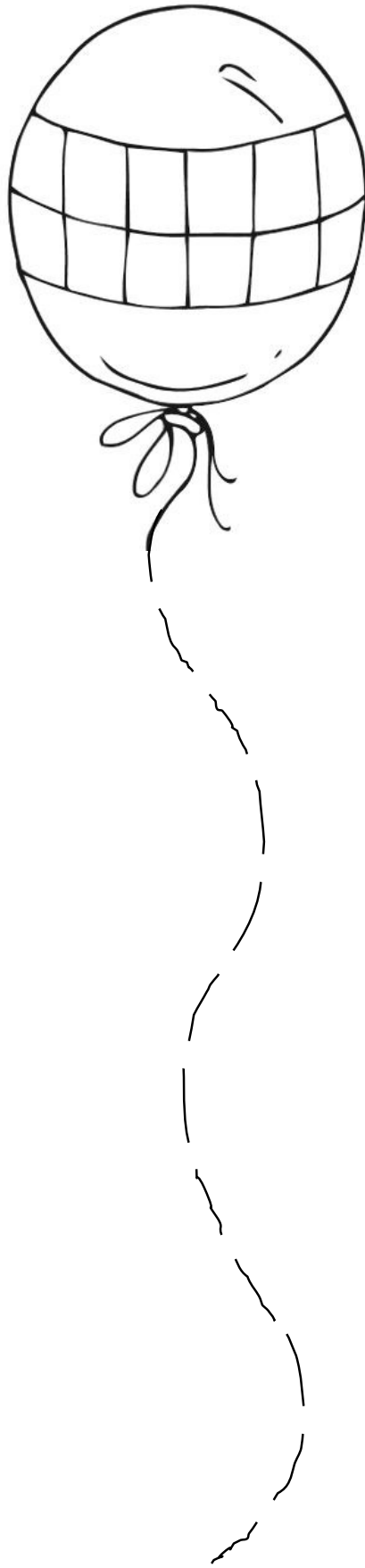

حوظ الاختلاف في الصورة كما في الشكل الأول.

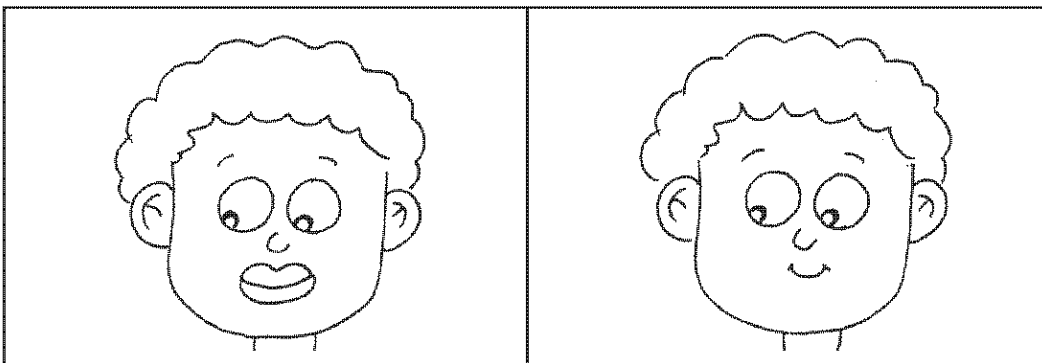
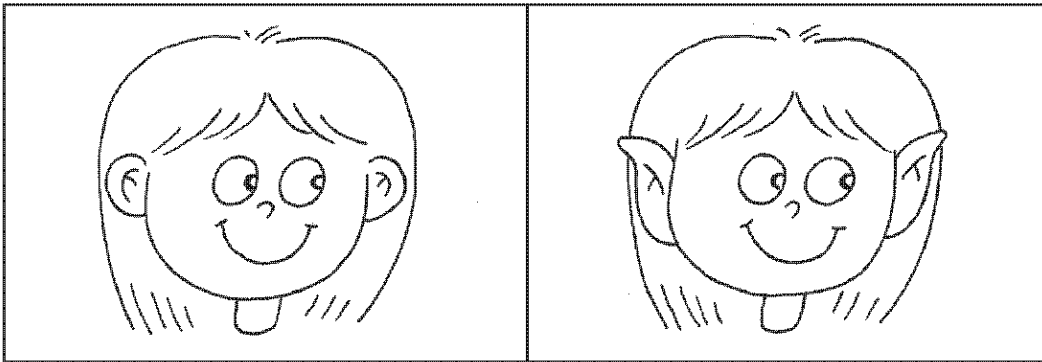
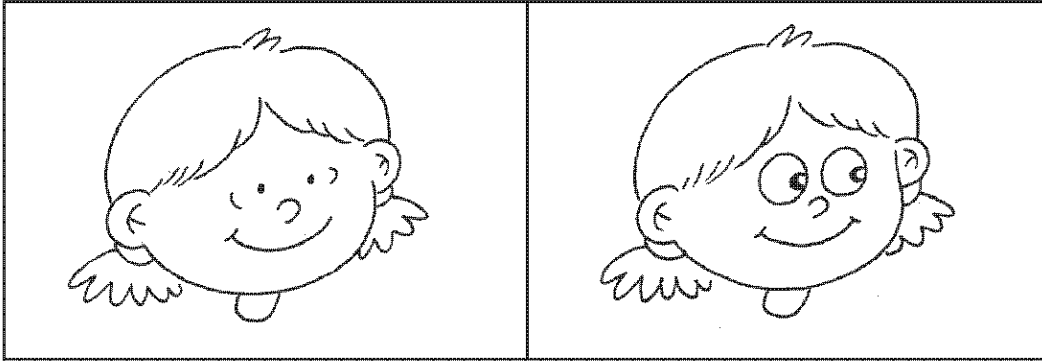
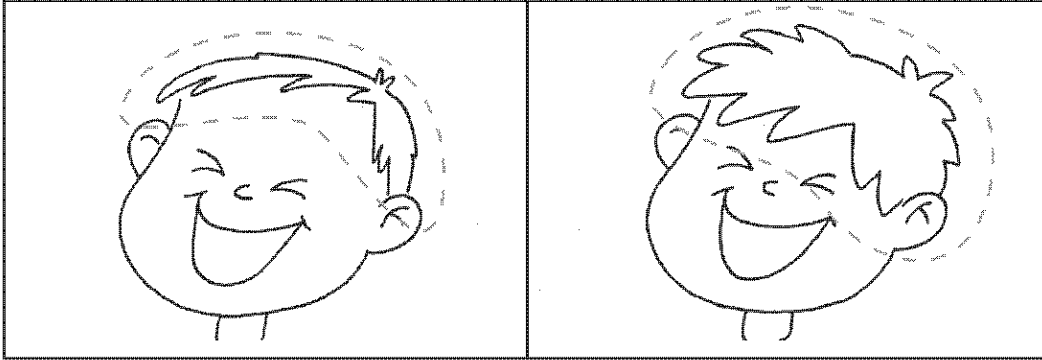

(فوق – تحت) الصق الكرة كما هو موضح ، من صفحة القصصات.

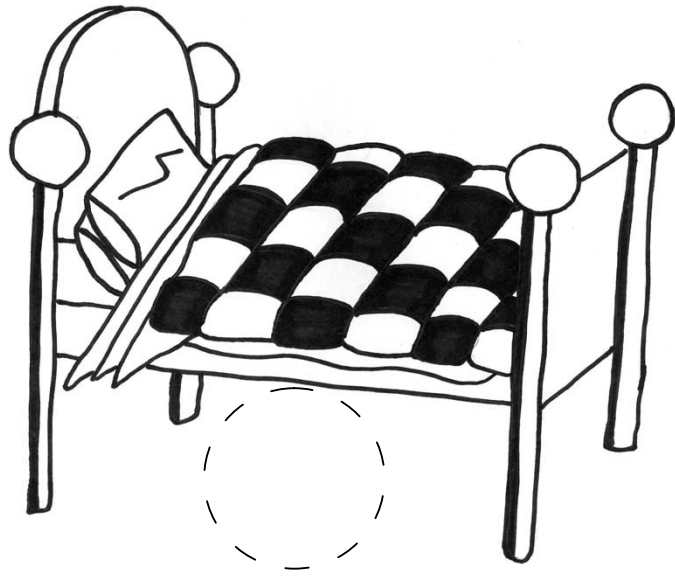
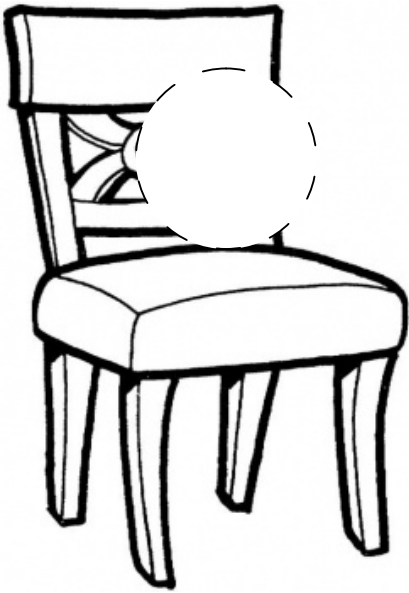
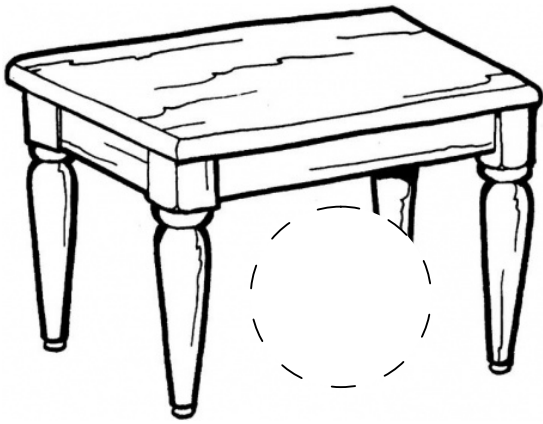

حوظ كل شكل مع الشكل المماثل له.

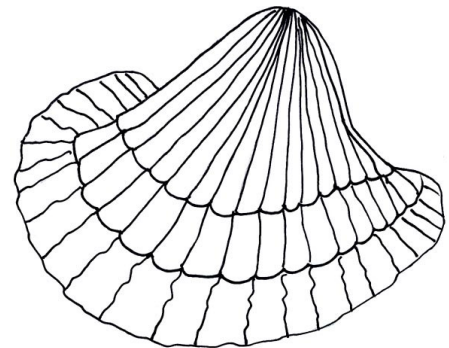
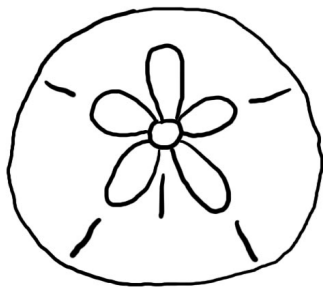
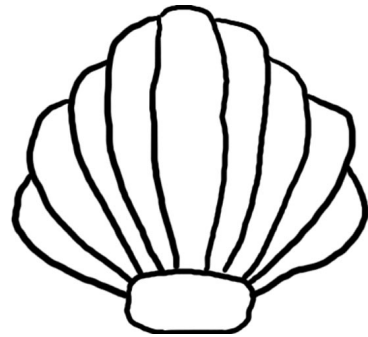
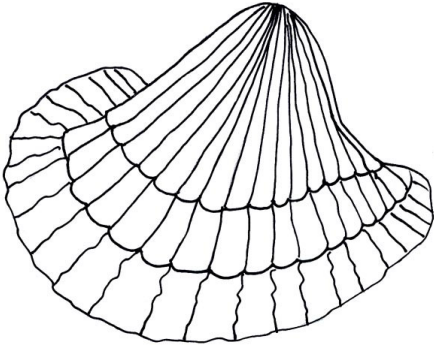
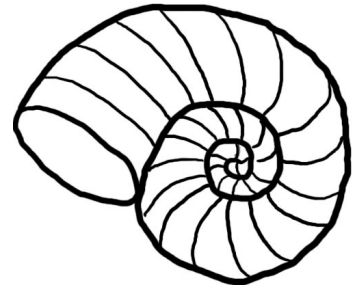
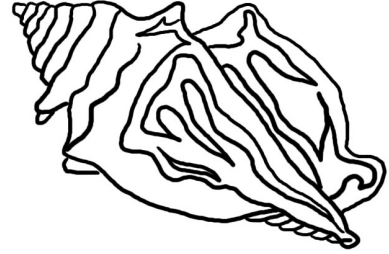
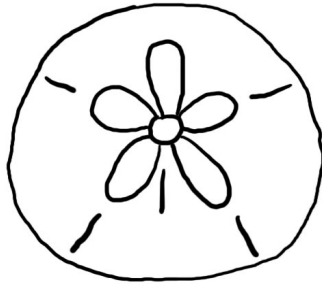
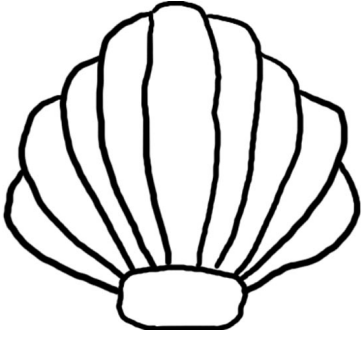

(مغلق – مفتوح) حوط ما هو مغلق باللون الأحمر وما هو مفتوح باللون الأخضر.

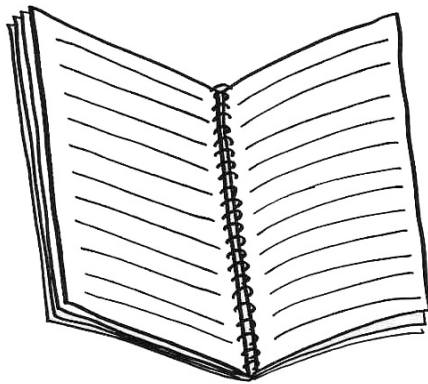
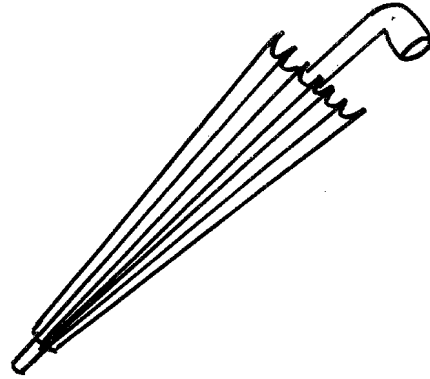
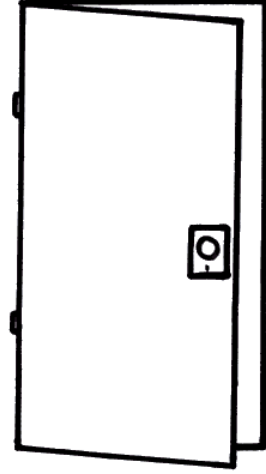
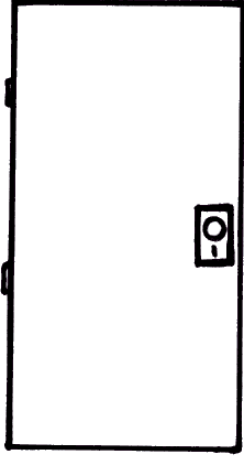

(كبير – صغير) لون الشكل الكبير باللون البرتقالي والشكل الصغير باللون الأصفر.

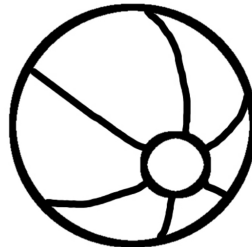
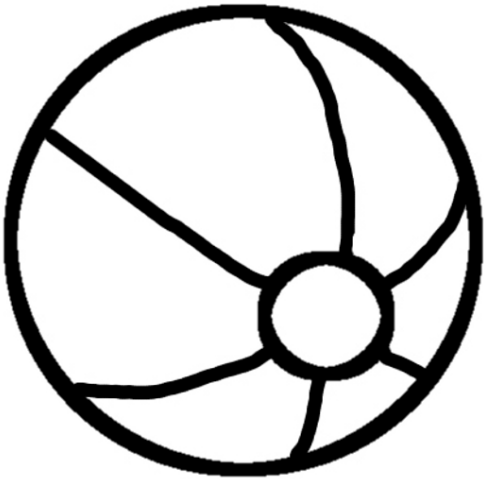
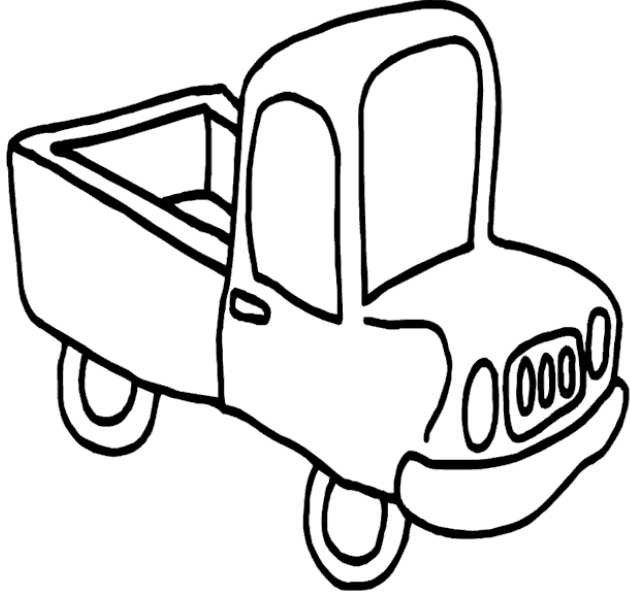
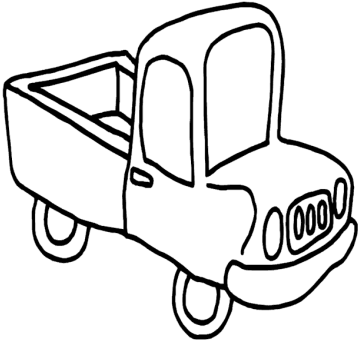
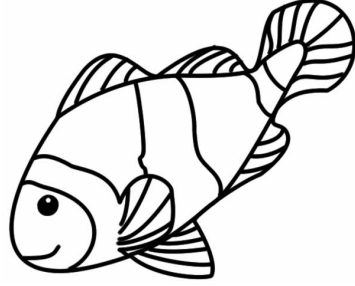
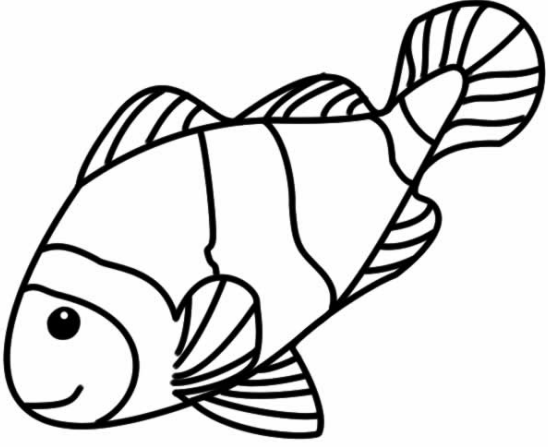



حوظ الشكل المختلف في كل مجموعة.

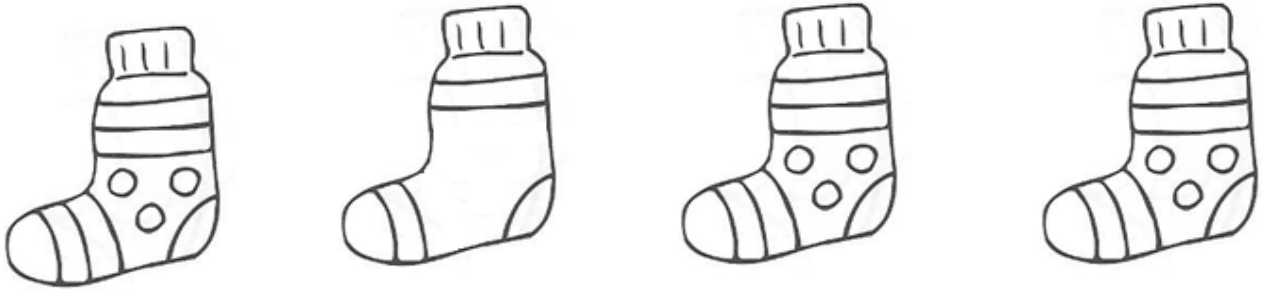
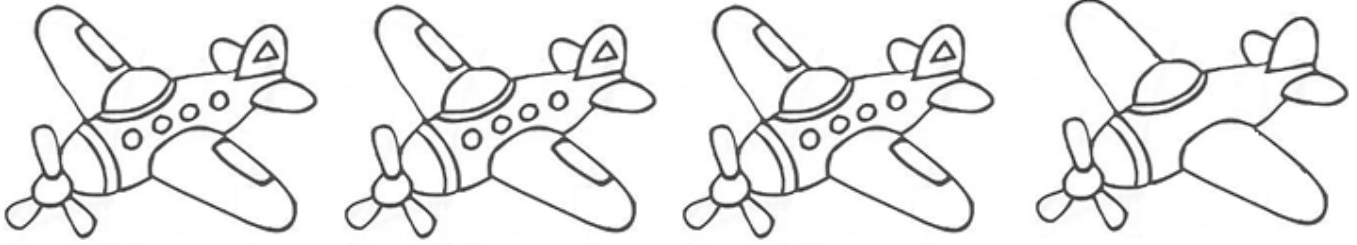

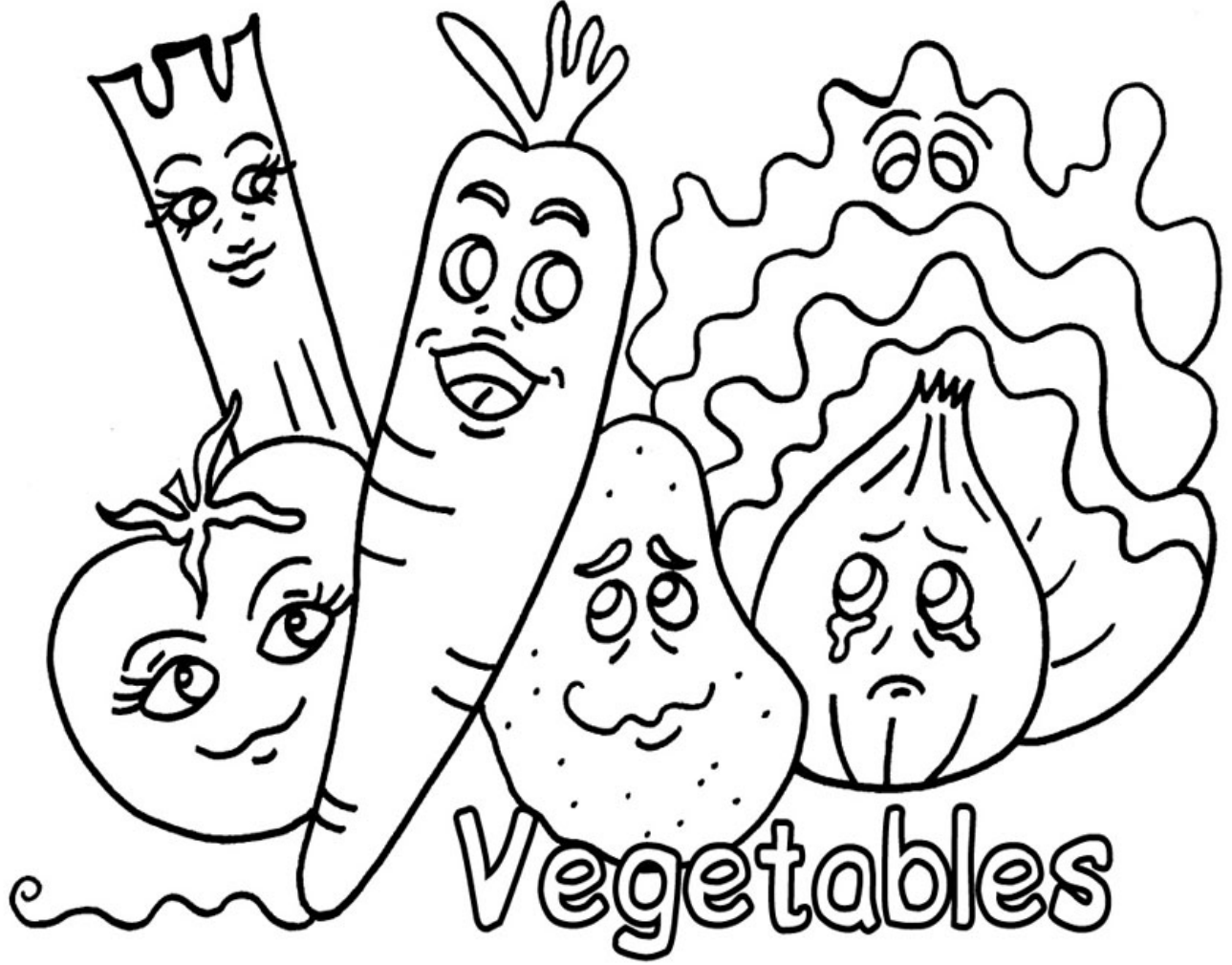

فَضْرَوَات

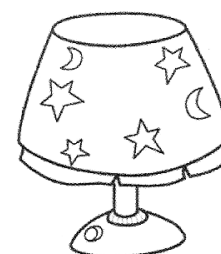
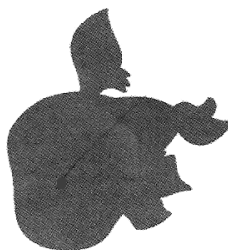
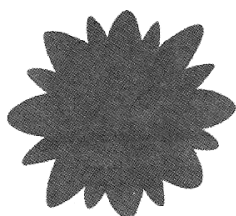
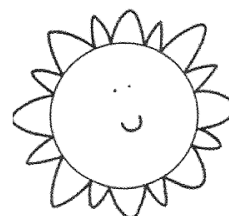
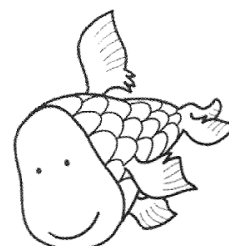

صل الملابس للبت في مكانه المناسب.

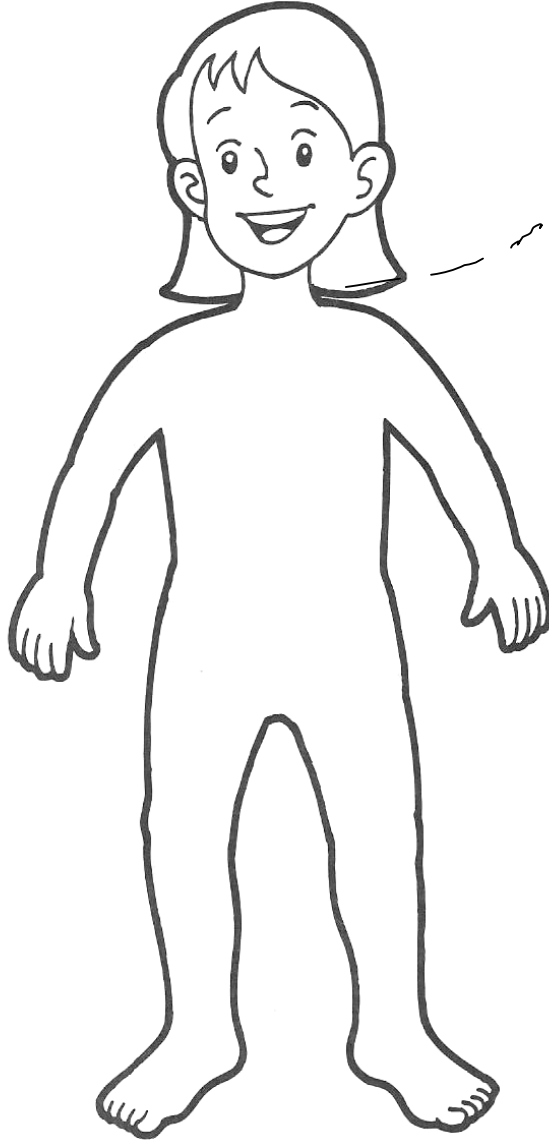
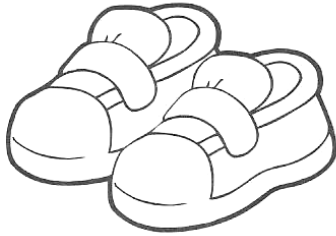
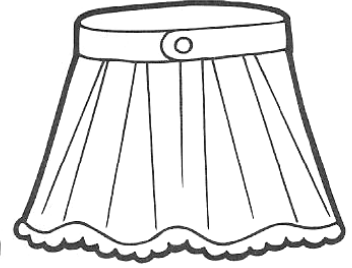
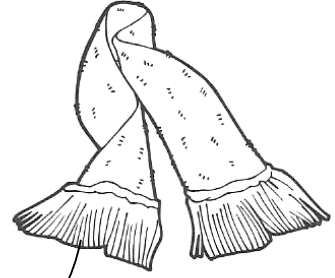
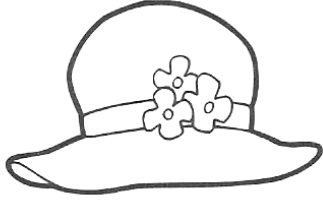

صل الرجل المناسبة لكل حيوان.

